

Weatherly Index No. 002

CATALOG NO.

CA0035

JUNE 2011



DODGE TRUCK- CUMMINS ENGINES

Replacement Parts Catalog

RELY ON US TO MAXIMIZE PERFORMANCE.



It takes advanced replacement parts to get top performance from a Dodge Ram diesel engine. So choose the brand service fleets trust to get the most from these engines: FP Diesel®

FP Diesel components and kits have been proven for years in medium and heavy-duty fleet engines across the country. These parts are designed using the latest in computer-aided design (CAD) and computer-aided engineering (CAE) technology, and are thoroughly researched to meet the most demanding specifications.

With FP Diesel you get a better solution: premium technologies engineered to address the unique demands placed on all diesel engines. It's a rebuild parts choice you can make with confidence.



In-frame and Overhaul Kits | Camshafts | Coolers
Engine Bearings | Engine Oil Seals | Expansion Plugs
Fuel | Gaskets | Lifters | Lubrication System & Oil Pumps
Piston Rings | Pistons | Push Rods | Rocker Arm Parts
Sleeves | Timing Components | Turbocharger & Connections
Valvetrain Parts | Water Pumps & Thermostats

Rely on us today for the complete range of FP Diesel replacement engine components!





Table of Contents

Global Technology Behind Every Part

Using the Catalog

How To Use This Catalog	II
Abbreviations.....	X
Conversion Tables	25
FP Diesel Philosophy	III
Manufacturing / Customer Service	IV
Coverage / Products.....	V
Engine Bearings – Material Selection / Bimetal Aluminum Alloys / Tri-Metal Alloys	VIII
Engine Kits / How to Specify FP Diesel Engine Kits.....	VI
Heavy Duty Pistons	VII
Piston Rings	IX
Warranty	XII

Product Information

1988-1991 6BTA5.9 Vin 8.....	1
1991-1996 6BTA5.9 Vin C	3
1997-1999 6BTA5.9 Vin D	7
1998-2005 6BTA5.9 Vin 6.....	9
1998-2004 6BTA5.9 Vin 7.....	14
2002-2008 6BTA5.9 H.O. Vin C	17
2007-2009 ISB6.7 Vin A	21
Numerical List.....	23
CPL Number List	26
Valve Stem Seal Identification	50





FP Diesel CA0035 Engine Parts Catalog

Global Technology Behind Every Part

The new CA0035 Heavy Duty Engine Parts Catalog contains all of the components currently offered from the FP Diesel brand for Dodge Truck applications using Cummins B Series engines for medium and heavy-duty truck engines.

This catalog is not intended to replace the Dodge Truck or Cummins parts books, CPL book, micro-fiche or service manuals. If in doubt about the parts for your particular application, consult your Dodge Truck or Cummins OE publications.

To get the right part for your particular engine, you must have the engine serial number or the Control Parts List (CPL) number. If you do not have this information, you may need the piston number, block casting number, connecting rod casting number, cylinder head casting number or crankshaft casting number to identify specific parts for your particular engine.

How To Use This Catalog

This catalog is designed to allow expedient identification of correct parts using the following information.

The catalog is sorted as follows:

- 1st** by VEHICLE or ENGINE MANUFACTURER.
- 2nd** by ENGINE DISPLACEMENT.
- 3rd** by BORE DIAMETER. Engines with the same displacement are sorted by bore diameter.
- 4th** by VALVETRAIN CONFIGURATION. 12 valve engines will be listed before 24 valve engines.

Each engine header provides all the information necessary to select the desired engine. Many of the headers include vehicle identification number listings to provide absolute assurance that the correct listing is being used.

The pages within the applications are easy to read and contain all the information required to select the correct part. The components in this catalog are listed in alphabetical order A through Z.

VIN CODE IDENTIFICATION

1981-2011 Model Years
1B7FD25P0BG 100001

Engine Type 8th Symbol	Model Year 10th Symbol
P	0





FP Diesel Philosophy

Global Technology Behind Every Part

FP Diesel – part of the Federal-Mogul Engine Systems group – is the industry's leading brand of premium heavy-duty replacement engine parts and gaskets, providing total engine system solutions for such well-known brands as Case®, Caterpillar®, Cummins®, Detroit Diesel®, IH/Navistar®, John Deere®, Komatsu®, Mack®, Waukesha® and White Superior®.

Federal-Mogul maintains a steadfast commitment to unsurpassed product quality and customer service. We serve construction, marine, agricultural, mining, gas compression, trucking and industrial markets around the globe. As the global leader in heavy-duty powertrain systems, Federal-Mogul is instrumental in the development of every new generation of gasoline and diesel engine technology. When you choose FP Diesel, you get unparalleled global engineering and manufacturing resources built into every product.

Today's medium and heavy duty commercial markets demand performance. Performance means precision-engineered parts that meet your demanding specifications; and are backed by a team of knowledgeable customer service representatives who can provide technical information and assistance; computerized order and inventory tracking for fast and accurate order fill; unprecedented warranty programs and a company-wide commitment to customer satisfaction.



Construction



Agriculture



On-Highway

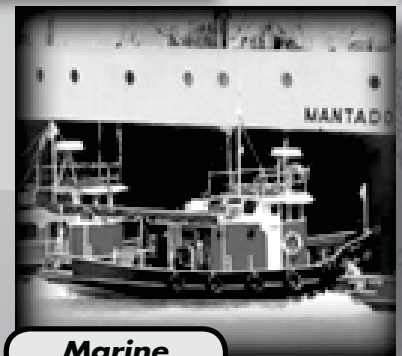

Marine

©2011 Federal-Mogul Corporation. FP Diesel and their respective designs are registered trademarks of Federal-Mogul Corporation. Case® is the registered trademark of Case Corporation, Inc.; Cat® and Caterpillar® are the registered trademarks of the Caterpillar, Inc.; Cummins® is the registered trademark of Cummins Engine Company; Detroit Diesel® is the registered trademark of Detroit Diesel Corporation; IH/Navistar® is the registered trademark of International Truck and Engine Corporation; John Deere® is the registered trademark of Deere & Company; Komatsu® is the registered trademark of Komatsu Limited, Inc.; Mack® is the registered trademark of Mack Trucks, Inc.; Waukesha® is the registered trademark of the Waukesha Engine Division of Dresser Industries, Inc.; White Superior® is the registered trademark of White Superior Corporation, Inc. Jacobs® is a registered trademark of Jacobs Vehicle Systems. All rights reserved.



Manufacturing

Global Technology Behind Every Part



Precise manufacturing and fabricating techniques, rigorous quality control procedures, utilization of the latest CAD technology and innovative solutions to industry challenges – coupled with Federal-Mogul's global manufacturing capabilities – have established FP Diesel as the industry leader in the medium and heavy duty commercial market.

FP Diesel applies stringent quality control procedures with expertly skilled technicians supervising the manufacturing process in all phases to ensure that our parts will perform and last.

FP Diesel is a military approved supplier for the 53 Series Detroit Diesel engine. But the parts we supply for the 53 aren't the only ones that go through government testing. Every FP Diesel part must pass through high-level quality control. Plus, every part is tracked throughout the entire distribution process.

Customer Service

FP Diesel customer service representatives are among the most experienced and knowledgeable in the industry, with hands-on medium and heavy-duty experience and in-depth knowledge of engine parts and applications. With one call to your

representative you'll have answers to any product, technical, order processing, billing, warranty, pricing, order tracking or availability questions you may have. Customer service that goes the extra mile also means you not only get the parts you need, but expert assistance from a person who knows the market.



Plus, our computerized inventory system allows us to ship orders promptly anywhere in the world, while our easy-to-use cataloging system makes ordering FP Diesel parts fast and simple. For the parts and information you need, count on FP Diesel to go the extra mile.





Coverage

Global Technology Behind Every Part

The FP Diesel product offering is a comprehensive line of diesel and natural gas engine replacement parts that provides all the coverage necessary to meet your heavy-duty engine rebuilding needs. FP Diesel also offers a full line of gaskets and elastomeric products. For more specific information, please refer to our full-line catalogs, which are engine and machine specific and follow OEM format. To ensure exact part number replacement, these catalogs reference OEM part numbers and features technical information relating to the specific engine being serviced.



Products and Catalogs

Caterpillar

Replacement Caterpillar products cover 3200, 3300, 3400, 3500, D Series and G Series engines. This coverage extends from cylinder heads, fuel injection, cam and crankshafts, cylinder kits, valvetrain and electrical to engine bearings, transmission, hydraulic gasket sets and more. **Refer to FP Diesel catalog No. CA0010 (parts) and CA0020 (gaskets).**

Cummins

FP Diesel provides replacement parts coverage for V378, V504, V555, Small Vee Engines, VVT 903, 855 Series, N14, L10, B Series, C Series, VVT1710, N743 and K/KTA 18-, 38- and 50-liter engines, as well as components for Jacobs® brakes. **Refer to FP Diesel catalog No. CA0030.**

Detroit Diesel

FP Diesel offers the most complete coverage in the replacement parts industry for Detroit Diesel, with an extensive line of components and kits for the 8.2-liter, 53 Series, 60 Series, 71 Series, 92 Series and 149 Series engines. **Refer to FP Diesel catalog No. CA0040 for 2-cycle engines or FP Diesel catalog No. CA0045 for 4-cycle engines.**

John Deere

FP Diesel offers a broad range of in-frame and complete overhaul kits and related components for 300 Series, 400 Series, 500 Series and Powertech engines is available from FP Diesel. **Refer to FP Diesel catalog No. CA0085.**

Komatsu

Extensive coverage for Komatsu S6D155 and SA6D155 engines, as well as a full line of replacement parts for Komatsu machines using Cummins N743, KT/KTA 19-, 38- and 50-liter engines, and the Cummins 855. **Refer to FP Diesel catalog No. CA0085.**

Mack

FP Diesel has a broad line for Mack, early ENDT 675 and 676 engines, as well as parts for later EM6 with both two- and four-valve head configurations. **Refer to FP Diesel catalog No. CA0060.**

International/Navistar

International coverage extends from the 6.9 and 7.3 liter, DT-360 and DT-466 through the 9.0 liter engine. **Refer to FP Diesel catalog No. CA0050.** For agricultural applications, FP Diesel also services the DT-414 and DT-436 Case/I.H. engines. **For industrial and agricultural applications, refer to FP Diesel catalog No. CA0188.**

Case

FP Diesel has a complete range of kits and components for the 188, 207, 301, 366, 451 and 504-Case engines along with the 4-390 & 4T-390, 6-590 & 6T-590, 6T-830 & 6TA-830, LTA 10 and NTA 855 B/C III Cummins engines. **Refer to FP Diesel catalog No. CA0095.**

Commercial, Ag, Industrial Engines

The FP Diesel CA0188 catalog includes all the engine manufacturers not covered in the FP Diesel name-plate specific catalogs. Replacement engine components for Allis-Chalmers, Bedford, Bendix-Westinghouse, Briggs & Stratton, Buda, Case Tractor, Chevrolet MD Truck, Climax, Continental, Dodge MD Truck, Ford Tractor, GMC MD Truck, Hercules, IHC Tractor, Isuzu Forklift, KHD, Kohler, LeRoi, Massey Ferguson, Mercedes, Mazda Forklift, Minneapolis-Moline, Mitsubishi, Novo, Oliver, Perkins, Superior, Thermo-King, Volvo, Waukesha, White and Wisconsin are included in the **FP Diesel CA0188 catalog.**



Engine Kits

Global Engineering Behind Every Part

The FP Diesel Engine Kit program allows you to select a kit tailored to the job at hand. Whether performing a complete overhaul or in-frame repair, FP Diesel engine kits contain all the necessary components to complete the rebuild job. This comprehensive program provides you with the following:

- Concise application information
- One price look-up
- A full complement of oversizes and undersizes
- Master kits that include full gasket sets

Engine kits are listed at the back of this catalog and under the In-Frame and Overhaul specific sections.

How To Specify FP Diesel Engine Kits

Many FP Diesel engine kits have several variations in components that are available depending on the specific engine. Overhaul Kits are designed to contain all the parts necessary to rebuild a particular engine. To assure that the kit is correct and complete, all that is necessary is for you to supply the engine information located on the Data Plate on the side of the engine block. In some cases the block casting number and the connecting rod number are also required. This information enables your FP Diesel service representative to configure the Engine Kit to your particular requirements insuring that everything is properly accounted for. In cases where there are no variable components, we have pre-configured the kits to include all the necessary parts for that application.

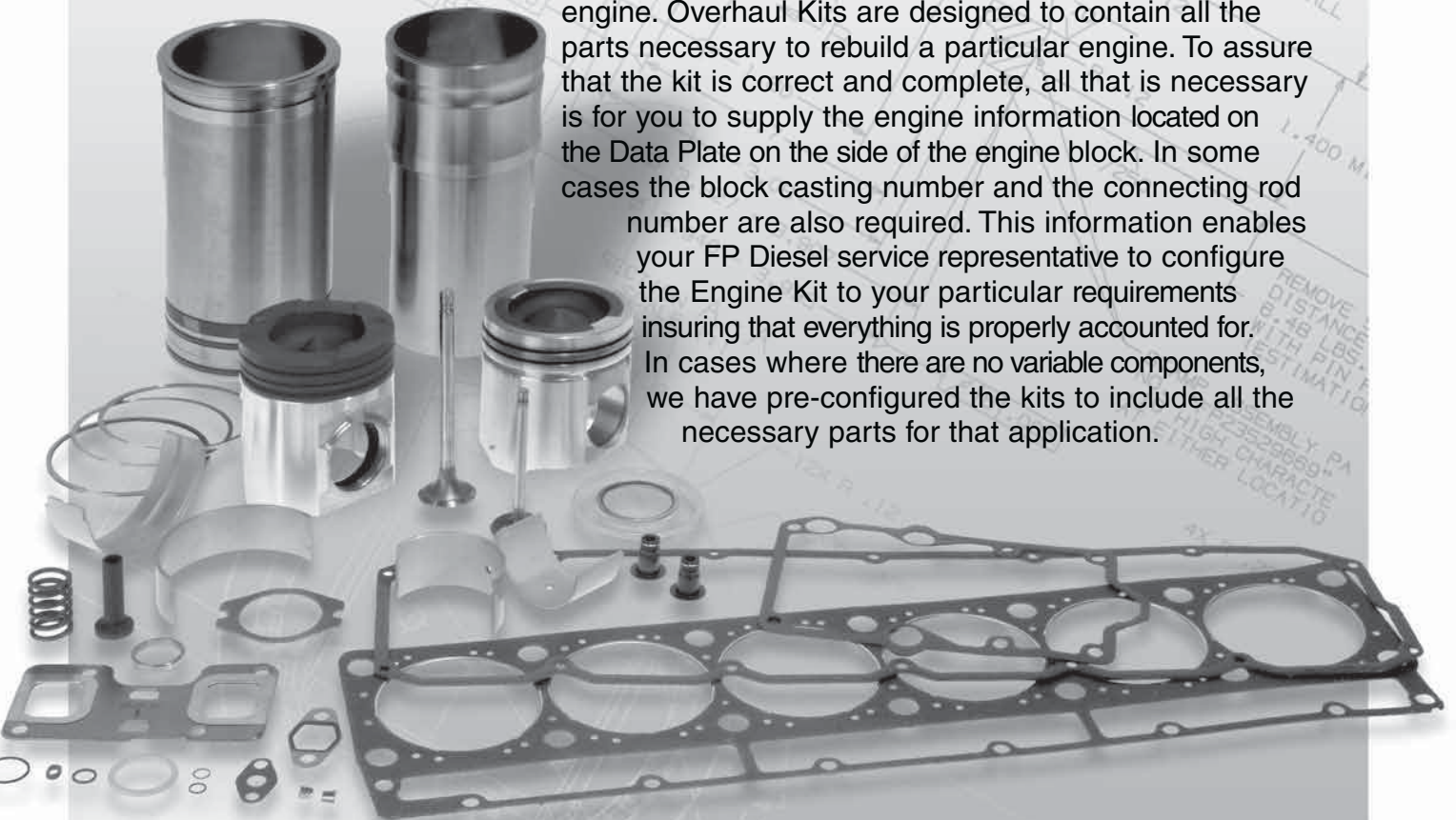



Engine Bearings

Global Technology Behind Every Part

Engine Bearing Material Selection

When selecting engine bearings, most rebuilders concentrate on getting the proper clearances and maintaining adequate oil pressure. Durability is expected from any bearing chosen, and the advantages of different bearing materials may not be considered. If engine operating conditions are considered and bearing materials chosen accordingly, the likelihood of engine longevity is greater. No single material can be correct for every application. FP Diesel engine bearings are equal to or better than the

original equipment specifications for material and design. We also provide alternatives to address unique problems and special needs.

In heavy duty applications there are a number of materials that will do an excellent job. Each alloy has advantages in terms of resistance to corrosion, rate of wear and fatigue strength. The latter characteristic is critical in engines that operate under high loads, generate considerable heat and may be subjected to occasional detonation.

Bi-Metal Aluminum Alloys – Plated and Unplated

Diesel fuels, moisture, and engine “blow-by” introduce many contaminants into the crankcase. Aluminum engine bearing materials provide outstanding resistance to the corrosive effects of these substances, and are the product of choice for most current original equipment vehicle manufacturers. The modern bi-metal aluminum engine bearing contains silicon. As a result of using silicon, the alloy resists seizure and dramatically

reduces or eliminates bearing wear. This contributes to today’s extended engine life. Aluminum is often the best material for a daily driven vehicle. Adding an overplate to an aluminum engine bearing will further enhance embedability and conformability. Continued efforts to remove lead from our environment guarantee that aluminum will become the preferred engine bearing material for most applications.

Tri-Metal Alloys

Tri-Metal engine bearings, such as our H-14 and H-24 alloys, have excellent fatigue resistance, but are less resistant to corrosion damage than aluminum bearings. These bearing materials are accepted by engine builders worldwide, and are proven to be reliable in a wide range of uses. While OE manufacturers are moving to aluminum for their needs, many rebuilders still specify the tri-metal bearings for older engines.

Typical Commercial Engine

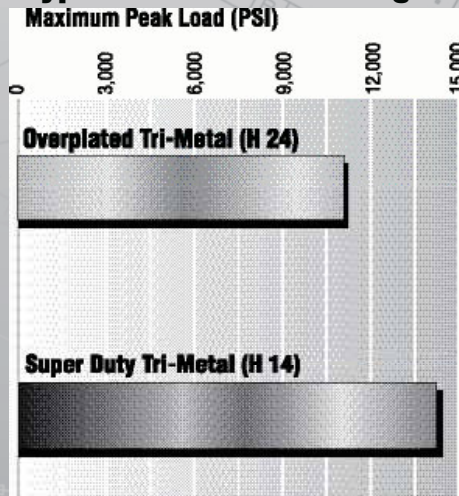



Piston Rings

Global Technology Behind Every Part

FP Diesel offers a broad range of piston rings that dominate the industry with technically advanced design, dedicated research and superior quality. Our rings minimize cylinder leakage under true operating conditions, and provide maximum oil control.

Top Ring

FP Diesel top rings provide reliable compression sealing and maximum power output, and control "blow-by." They are engineered for instant seating, superior cylinder sealing and optimum durability. We offer cast iron, high strength ductile iron, and steel material choices. All premium ring sets feature moly, chrome or plasma-moly facings for enhanced performance under demanding conditions. The inherent strength of our materials provides sealing integrity at extreme pressures and RPM. We supply rings for all popular applications: including medium and heavy duty, agricultural and high performance.

Second Ring

Second rings are manufactured from SAE-J929a iron to provide excellent durability and superior oil control. The primary function of the second ring is oil control. Our tapered face design makes this ring work as a "scraper," reducing the potential for oil migration into the combustion chamber.

The race-proven gap design creates an escape path for residual combustion gases, reducing inter-ring pressure and keeping the top ring seated against its groove. Without this escape path, trapped pressure will unseat the top ring, causing ring flutter and reduced cylinder seating at high RPM. Our one-piece second rings are far more effective and reliable than competitive designs which attempt to retain combustion pressure lost through ineffective top rings. Beware: cylinder leakage tests are steady-state; they do not account for time, piston movement or true operating pressures.

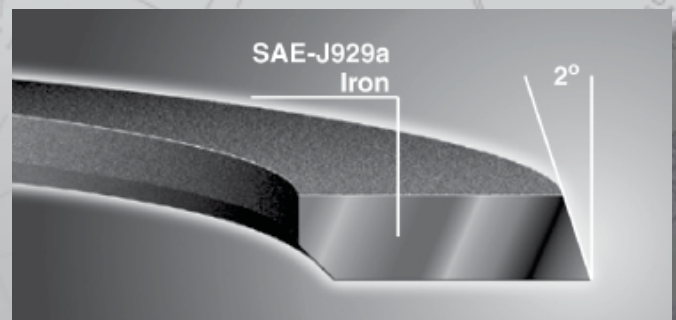
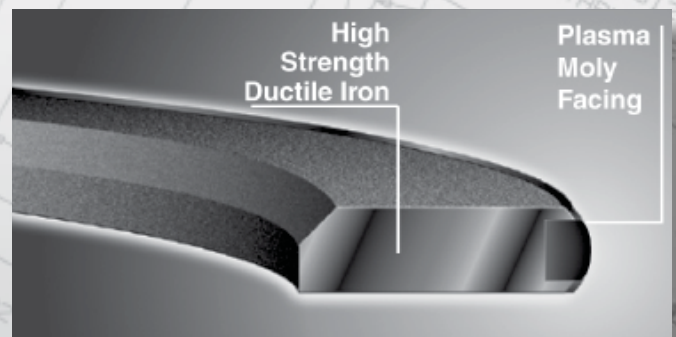



Abbreviations Used

Global Technology Behind Every Part

ABBREVIATION	DESCRIPTION
&	And
2WD	Two Wheel Drive
4WD	Four Wheel Drive
A.I.R.	Air Injector Reactor
A/C	Air Conditioning
A/R	As Required
A/T	Automatic Transmission
ABS	Anti-lock Brake System
AC	Alternating Current
Acc.	Accessory
Adj.	Adjustable
Adv.	Advance
Aft	After
Alt.	Altitude
Alum.	Aluminum
Amp.	Ampere
AOD	Automatic Overdrive
Appl.	Application
Approx.	Approximately
Asst.	Assist
Assy.	Assembly
ATV	All Terrain Vehicle
Auto.	Automatic
Auto. Trans.	Automatic Transmission
Aux.	Auxiliary
Avail.	Available
Avg.	Average
AWD	All Wheel Drive
Bal.	Balance
Batt.	Battery
Bbl.	Barrel
Bbl. Carb.	Barrel Carburetor
Bef.	Before
Brg.	Bearing
Brkt.	Bracket
C	Celsius
C.I.	Cast Iron
C.R.	Compression Ratio
C/L	Centerline
Calib.	Calibration
Calif.	California
Cam	Camshaft
Can.	Canada
Carb.	Carburetor
Cat.	Catalytic
cc	Cubic Centimeter
CCW	Counter Clockwise
CD	Compression Distance
CFFI	Cross Fire Injection
CFI	Central Fuel Injection
CFM	Cubic Feet per Minute
CID	Cubic Inch (Displacement)
Cld.	Cooled
Clg.	Cooling
Clr.	Cooler

ABBREVIATION	DESCRIPTION
cm	Centimet
Cntr. Bore	Counter Bore
Compl.	Complete
Con. Rod	Connecting Rod
Cruise	Cruise Control
Ctr.	Center
CW	Clockwise
Cyl.	Cylinder
Cyl. Hd.	Cylinder Head
DC	Direct Current
Deg.	Degree
DFI	Digital Fuel Injection
DI	Direct Injection
Dia.	Diameter
Dim.	Dimension
Dir. Inj.	Direct Injection
Disc.	Discontinued
Dist.	Distributor
DOHC	Dual Overhead Camshaft
Dr.	Door or Drive
E.E.C.	Electronic Engine Control
E.I.S.	Electronic Ignition System
Ea.	Each
Ecc.	Eccentric
ECM	Electronic Computer Module
ECM	Electronic Control Module
ECM	Engine Control Module
Econ.	Economy
ECS	Electronic Controlled Spark
EFI	Electronic Fuel Injection
Elec.	Electric
Emis.	Emission
Eng.	Engine
Equip.	Equipment
Etc.	Et Cetera
Exc.	Except
Exh.	Exhaust
Exp.	Export
Ext.	Exterior
Ext.	External
F	Fahrenheit
Fed.	Federal
FI	Fuel Injection
Flex.	Flexible
Flg.	Flange
Flwr.	Follower
Frg.	Forged or Forging
Frnt.	Front
FWD	Front Wheel Drive
Gal.	Gallon
Gas	Gasoline
GPH	Gallons Per Hour
GPM	Gallons Per Minute
Grv(s)	Groove(s)
Gskt.	Gasket
GVW	Gross Vehicle Weight
H/D	Heavy Duty
Hd.	Head
HEI	High Energy Ignition
Hi	High





Abbreviations Used

Global Technology Behind Every Part

ABBREVIATION DESCRIPTION

Hi Alt.	High Altitude
Hi-Perf.	High Performance
Hi-Temp.	High Temperature
HO	High Output
Horiz.	Horizontal
HP	Horsepower
HSC	High Swirl Combustion
Hyd.	Hydraulic
I/C	Intercooler
I.D.	Identification
ID	Inside Diameter
IDI	Indirect Injection
In. Frm.	In Frame
in.	Inch
Incl.	Includes
Ind.	Industrial
Inj.	Injection
Int.	Intake
Inter.	Intermediate
L	Liter
L.H.	Left Hand
L/D	Light Duty
Lgth.	Length
LPG	Liquid Propane Gas
M/D	Medium Duty
M/T	Manual Transmission
Man.	Manual
Man. Trans.	Manual Transmission
Max.	Maximum
Mech.	Mechanical
MFI	Multi-Port Fuel Injection
Min.	Minimum
mm.	Millimeters
MPH	Miles Per Hour
Mtl.	Material
N/A	Not Available
N/R	Not Required
Nat.	Natural
Nat. Asp.	Naturally Aspirated
Neg.	Negative
Neut.	Neutral
No.	Number
Nom.	Nominal
Norm.	Normal
O.A.L.	Overall Length
O.E.	Original Equipment
O/D	Overdrive
O/S	Oversize
Obs.	Obsolete
OD	Outside Diameter
OEM	Original Equipment Manufacturer
OHC	Overhead Cam
OHV	Overhead Valve
Opt.	Optional
Orig.	Original
oz.	Ounce
P. T.O.	Power Take Off
P/S	Power Steering
Pass.	Passenger

ABBREVIATION DESCRIPTION

Pc(s)	Piece(s)
PCV	Positive Crankcase Ventilation
Perf.	Performance
Pkg.	Package
Pos.	Positive
Prem.	Premium
Pri.	Primary
PSI	Pound Per Square Inch
Pwr.	Power
Qtr.	Quarter
Qty.	Quantity
R.B.P.	Ring Below Pin
R.H.	Right Hand
Ref.	Reference
Reg.	Regular
Reman	Remanufactured
Req'd	Required
Rev.	Revision
Rev. Rot.	Reverse Rotation
Rlr.	Roller
RMB	Rear Main Bearing
Rot.	Rotatiovn
RPM	Revolutions Per Minute
Rr.	Rear
RWD	Rear Wheel Drive
S/C	Supercharged
Seal. Rings	Sealing Rings
Ser.	Serial or Series
Ser. No.	Serial Number
SFI	Sequential Fuel Injection
Slv.	Sleeve
SOHC	Single Overhead Cam
Spd.	Speed
Spec.	Special
Sta.	Station
Std.	Standard
Sys.	System
T/C	Turbocharged
Tach	Tachometer
TBI	Throttle Body Injection
Temp.	Temperature
TPI	Tuned Port Injection
Trans.	Transmission
Trk.	Truck
TTY	Torque-to-Yield
TURBO	Turbocharged
U/S	Under Size
Veh.	Vehicle
VIN	Vehicle Identification Number
VIV	Valve
VSS	Valve Stem Seal
w/	With
w/o	Without
Wagon	Station Wagon
Wt.	Weight



Warranty

Global Technology Behind Every Part

The products listed in this catalog are warranted to be free from defects in material and workmanship, under normal use and service, for two years from date of installation in an engine, without mileage or hour qualification in accordance with the following limited warranty. This warranty is the sole and exclusive warranty for failure of the above parts. This exclusive remedy shall not be deemed to have failed of its essential purpose so long as Federal-Mogul is willing and able to provide the remedy provided below.

WARRANTY LIMITATIONS

Federal-Mogul agrees to only pay for parts and labor needed to repair engine damages that result from the defined warranty failure. The costs are limited to parts and labor necessary for restoring the engine to its condition immediately prior to the failure. Labor costs are determined by current published rates and standards in the geographic area in which repairs are performed. Overtime or holiday rate charges are not allowed. We will also pay for maintenance products such as oil, antifreeze, belts, hoses and filter elements that are damaged because of a defined warranty failure.

Federal-Mogul is not responsible for engine failure resulting from owner, operator or third party neglect or abuse, improper installation or repair procedures, alteration or misapplication of parts, failure to properly service or maintain the engine and vehicle in accordance with applicable OEM operation and maintenance manuals or use in engine modified for competition purposes or used in competition.

OTHER THAN AS EXPRESSLY PROVIDED HEREBY, FEDERAL-MOGUL SHALL NOT, UNDER ANY CIRCUMSTANCES, BE LIABLE FOR ANY SPECIAL, INDIRECT, INCIDENTAL, OR CONSEQUENTIAL DAMAGES, INCLUDING, BUT NOT LIMITED TO, DAMAGE OR LOSS OF OTHER PROPERTY OR EQUIPMENT, LOSS OF PROFITS OR REVENUE, TRANSPORTATION AND TOWING COSTS, COST OF PURCHASED OR REPLACED GOOD, OR CLAIMS OF CUSTOMERS OF THE PURCHASER, WHICH MAY ARISE OR RESULT FROM THE SALE, INSTALLATION, OR USE OF THESE PARTS. Some jurisdictions do not allow limitations on how long an implied warranty will last or the exclusion or limitation of incidental or consequential damages, so the limitations or exclusions contained herein may or may not apply to you. This warranty gives you specific legal rights. You may also have other rights depending on the state or province in which you reside.

THIS WARRANTY IS IN LIEU OF ALL OTHER WARRANTIES, EXPRESS AND/OR IMPLIED, INCLUDING, WITHOUT LIMITATION, WARRANTIES OF MERCHANTABILITY AND OF FITNESS FOR A PARTICULAR PURPOSE AND THEY ARE EXCLUDED TO THE EXTENT THEY EXCEED THE WARRANTY COVERAGE DESCRIBED BY THIS WARRANTY.

This warranty and remedy apply to new FP Diesel engine parts from Federal-Mogul sold directly to our authorized aftermarket customers as evidenced by completed claim documentation. No agent or sales representative of Federal-Mogul Corporation has the authority to modify this warranty. Other Federal-Mogul parts may carry different warranties.

Federal-Mogul must be notified by the customer: (i) before filing a warranty claim, (ii) within one year of the date that the claim accrues, and (iii) before any work has been performed. All claims must be submitted in writing and Federal-Mogul reserves the right to examine all parts, systems and related information associated with the claim. (Note all shipping charges are the responsibility of the end-user or distributor, Federal-Mogul will not accept collect shipments). See your sales representative for detailed claim submission procedures and forms.

Use parts only for applications and interchanges in this catalog.

Failure to heed this warning could result in reduced life or failure of the part. All parts listed in this catalog are not for use in space program, atomic energy/nuclear reactor equipment, medical or aircraft applications. Federal-Mogul reserves the right to make product improvements/changes, with respect to similar products previously manufactured, without notice and without incurring liability.



Les produits indiqués dans ce catalogue sont garantis contre toute défectuosité de matériel et de fabrication, dans des conditions d'utilisation et d'entretien normales, sur une période de deux ans à partir de la date d'installation dans un moteur, sans qualification de kilométrage ou horaire, conformément à la garantie limitée suivante.

Cette garantie est la garantie unique et exclusive pour la défaillance des pièces précitées. Ce recours exclusif ne doit pas être présumé comme ayant échoué à son objectif essentiel, tant que Federal-Mogul approuve et est capable de fournir le recours fourni ci-dessous.

LIMITATIONS DE GARANTIE

Federal-Mogul accepte uniquement de payer les pièces et la main-d'œuvre nécessaires pour réparer les dommages de moteur qui résultent de la défaillance de la garantie définie. Les coûts sont limités aux pièces et à la main-d'œuvre nécessaires pour la restauration du moteur à l'état auquel il se trouvait juste avant la défaillance.

Les frais de main-d'œuvre sont déterminés par les prix et normes publiés à l'heure actuelle dans la zone géographique dans laquelle les réparations sont effectuées. Les heures supplémentaires ou les frais de jours fériés ne sont pas permis. Nous payons également les produits d'entretien, tels que l'huile, l'antigel, les courroies, les tuyaux et les éléments de filtre qui sont endommagés en raison d'une défaillance de garantie définie.

Federal-Mogul décline toute responsabilité pour une défaillance de moteur découlant d'une négligence ou d'un abus infligés par le propriétaire, l'opérateur ou une tierce partie, de procédures d'installation ou de réparations incorrectes, de l'altération ou d'une application incorrecte de pièces, d'un manque de réparation ou d'entretien adéquat du moteur et du véhicule conformément aux manuels d'utilisation et d'entretien OEM applicables, ou de l'utilisation dans un moteur modifié à des fins de compétition ou utilisé en compétition.

SAUF SUR SPÉCIFICATION EXPRESSE DANS LA PRÉSENTE, FEDERAL-MOGUL NE SERA RESPONSABLE, EN AUCUNE CIRCONSTANCE, POUR DES DOMMAGES SPÉCIAUX, INDIRECTS, ACCESSOIRES OU CONSÉCUTIFS, Y COMPRIS, SANS S'Y LIMITER, DES DOMMAGES OU LA PERTE D'UNE AUTRE PROPRIÉTÉ OU D'UN AUTRE ÉQUIPEMENT, LA PERTE DE PROFITS OU DE REVENUS, LES FRAIS DE TRANSPORT ET DE REMORQUAGE, LES FRAIS DE BIENS ACHETÉS OU REMPLACÉS, OU LES DEMANDES DE CLIENTS DE L'ACHETEUR, QUI PEUVENT SE PRÉSENTER OU RÉSULTER DE LA VENTE, DE L'INSTALLATION OU DE L'UTILISATION DE CES PIÈCES.

Certaines juridictions ne permettent pas les limites sur la durée d'une garantie implicite, ni l'exclusion ou la limitation de dommages accessoires ou consécutifs, et, par conséquent, les limitations ou exclusions ci-incluses peuvent s'appliquer ou non pour votre cas. Cette garantie vous octroie des droits légaux spécifiques.

Vous disposez également d'autres droits en fonction de l'état ou de la province de votre résidence.

LA PRÉSENTE GARANTIE REMPLACE TOUTES AUTRES GARANTIES, EXPRESSES ET/OU IMPLICITES, Y COMPRIS, SANS S'Y LIMITER, LES GARANTIES DE QUALITÉ MARCHANDE OU D'ADAPTATION À UN USAGE PARTICULIER, ET ELLES SONT EXCLUES SI ELLES DEVAIENT DÉPASSER LA COUVERTURE DE GARANTIE DÉCRITE PAR LA PRÉSENTE GARANTIE.

Cette garantie et le recours s'appliquent aux nouvelles pièces du moteur diesel FP de Federal-Mogul vendu directement à nos clients de pièces de rechange autorisés, tel qu'attesté par les documents de demande dûment remplis. Aucun agent ou représentant de ventes de Federal-Mogul Corporation ne dispose du droit de modifier la présente garantie. D'autres pièces de Federal-Mogul peuvent être couvertes par des garanties différentes.

PROCÉDURES DE DEMANDE

Le client doit notifier Federal-Mogul : (i) avant de remplir une demande au titre de la garantie, (ii) en l'espace d'un an à partir de la date à laquelle la demande est exercée, et (iii) avant l'exécution d'un travail quelconque.

Toutes les demandes doivent être soumises par écrit et Federal-Mogul se réserve le droit d'examiner toutes les pièces, tous les systèmes et toutes les informations associées à la demande.

(Veuillez noter que l'utilisateur final ou le distributeur est responsable pour tous les frais d'expédition; Federal-Mogul n'accepte aucun envoi en port-dû). Veuillez consulter votre représentant des ventes pour les formulaires et les procédures de soumission de demande détaillés.

AVERTISSEMENT

Utilisez uniquement les pièces pour les applications et les échanges de ce catalogue.

Un manque de respect de cet avertissement pourrait résulter en une durée de vie réduite ou une défaillance de la pièce. Aucune des pièces indiquées dans ce catalogue n'est destinée à être utilisée dans un programme d'espace, pour du matériel de réacteur nucléaire/d'énergie atomique, ou des applications médicales ou d'aéronefs.

Federal-Mogul se réserve le droit d'effectuer des améliorations/changements de produits, en ce qui concerne des produits similaires fabriqués auparavant, sans avis et sans assumer de responsabilité.



Warranty

Global Technology Behind Every Part

Se garantiza que todos los productos presentados en este catálogo no presentaran defecto alguno, ya sea en su material ni en su fabricación, bajo condiciones de uso y servicio normales. La garantía es de dos años de la fecha de la instalación en el motor, sin límites en el kilometraje o en las horas de funcionamiento. Esta es la única y exclusiva garantía si alguna de las partes listadas fuese a fallar. Este recurso exclusivo no se tomará como una falta, siempre y cuando Federal Mogul pueda remediarlo con las provisiones enumeradas mas abajo.

LIMITACIONES DE LA GARANTIA

Federal-Mogul pagará solo por las partes y la mano de obra necesarias para reparar daños al motor que resulten de una falla definida sobre la parte vendida. Los costos quedarán limitados a las partes y la mano de obra necesarias para restaurar el motor a la condición en la cual se encontraba inmediatamente antes de la falla. Los costos de la mano de obra se determinarán por medio de precios publicados y estándares del área geográfica en la cual las reparaciones se lleven a cabo. No se permitirá agregar costos de tiempo extra ni por trabajo durante días festivos. Pagaremos por productos de mantenimiento tales como aceite, anti-congelantes, correas, mangueras y filtros dañados debido a alguna falla definida del producto vendido.

Federal-Mogul no se hará responsable por una falla de motor causada por el dueño, operador o un tercero, ya sea por su propia negligencia, abuso o instalación inadecuada o procedimientos de reparación inadecuados, por alteración o aplicación incorrecta de las partes, falta de servicio necesario o mantenimiento del motor o de el vehículo de acuerdo a los manuales de operación y mantenimiento de acuerdo fabricante original, o por la modificación de un motor para su uso en competencias o por haber sido usado en competencias.

FEDERAL-MOGUL NO SERÁ RESPONSABLE, BAJO NINGUNA CIRCUNSTANCIA, OTRO QUE NO SEA LO QUE SE HA MENCIONADO EXPLÍCITAMENTE EN ÉSTA GARANTÍA, POR CUALQUIER DAÑO INDIRECTO, ESPECIAL, ACCIDENTAL O CÓMO CONSECUENCIA DE OTROS DAÑOS, INCLUYENDO, PERO SIN QUE QUÉDE LIMITADO A DAÑOS O PÉRDIDAS DE BIENES O DE EQUIPO, PÉRDIDA DE GANANCIAS O INGRESOS, COSTOS DE GRÚA O TRANSPORTACIÓN, DE PARTES REEMPLAZADAS , O RECLAMOS DE CLIENTES DEL COMPRADOR, QUE PUEDAN RESULTAR DE LA VENTA, INSTALACIÓN, O USO DE ÉSTAS PARTES.

Algunas jurisdicciones no permiten limitaciones con respecto a la duración de garantías implícitas, o a la exclusión o limitación de daños accidentales, por lo tanto puede que las limitaciones o exclusiones contenidas en el presente no le apliquen a Ud. Esta garantía le ofrece derechos específicos. Ud. puede gozar de derechos adicionales dependiendo del estado o provincia en la cual viva.

ÉSTA GARANTIA REEMPLAZARA CUALQUIER Y TODA OTRA GARANTÍA, YA SEA EXPLÍCITA U IMPLÍCITA, INCLUYENDO, PERO NO LIMITANDOSE A GARANTÍAS PARA LA MERCANCÍA Y USO DE LA MISMA CON UN PROPÓSITO EN PARTICULAR, Y ESAS MISMAS QUEDARAN EXCLUIDAS SI EXCEDEN LA COBERTURA DESCRITA EN ÉSTA GARANTÍA.

Ésta garantía y recurso aplican a partes nuevas de motores de FP Diésel, vendidas directamente a nuestros clientes autorizados del mercado de reposición, lo cual será corroborado por medio de documentación usada en el reclamo.

Ningún agente o representante de la empresa Federal-Mogul tiene autoridad para modificar ésta garantía. Otras partes de Federal-Mogul pueden tener garantías diferentes.

PROCEDIMIENTO PARA PRESENTAR UN RECLAMO

Federal-Mogul debe ser notificado por el cliente: (i) antes de presentar un reclamo cubierto en la garantía, (ii) dentro del plazo de un año de ocurrida la falla, y (iii) antes de que se haya hecho algún trabajo.

Todo reclamo debe ser entregado por escrito y Federal-Mogul reserva el derecho a examinar todas las partes, sistemas e información relacionados y asociados al reclamo. (Todo cargo de envío será responsabilidad del usuario final o distribuidor, Federal-Mogul no aceptará envíos a cobrar). Contacte a su representante de ventas para conseguir el formulario de reclamos con el procedimiento detallado.

ADVERTENCIA

Las partes deben ser usadas sólo para las aplicaciones mencionadas en éste catálogo. El no seguir ésta advertencia puede que resulte en que le falle la parte o a que su vida quede reducida. Todas las partes listadas en éste catálogo no están hechas para el uso en programas espaciales, para equipos de energía atómica, o reactores nucleares, o para aplicaciones médicas ni en naves aéreas. Federal-Mogul se reserva el derecho de hacerle mejoras y cambios a los productos, con respecto a productos similares que se hayan fabricado previamente, sin notificación o responsabilidad legal alguna.

Engine Finding Index												
Litres	CID	CC	Block Type	Bore	Valves	Mfg.	Vin	Eng. Code	Fuel Del. Type	Years	Line	
5.9L	359	5882cc	OHV Turbo - Intercooled L6	102mm	12	Cummins Eng.	8	6BTA5.9	MFI/Diesel	1991-1988	1	
5.9L	359	5882cc	OHV Turbo - Intercooled L6	102mm	12	Cummins Eng.	C	6BTA5.9	MFI/Diesel	1996-1991	2	
5.9L	359	5882cc	OHV Turbo - Intercooled L6	102mm	12	Cummins Eng.	D	6BTA5.9	MFI/Diesel	1999-1997	3	
5.9L	359	5882cc	OHV Turbo - Intercooled L6	102mm	24	Cummins Eng.	6	6BTA5.9	MFI/Diesel	2005-1998	4	
5.9L	359	5882cc	OHV Turbo - Intercooled L6	102mm	24	Cummins Eng.	7	6BTA5.9	MFI/Diesel	2004-1998	5	
5.9L	359	5882cc	OHV Turbo - Intercooled L6	102mm	24	Cummins Eng.	C	6BTA5.9	MFI/Diesel	2008-2002	6	
6.7L	408.3	6691cc	OHV Turbo - Intercooled L6	107mm	24	Cummins Eng.	A	ISB6.7-305	MFI/Diesel	2009-2007	7	

Engine Code Index												
Eng. Code	Litres	CID	CC	Block Type	Bore	Valves	Mfg.	Vin	Fuel Del. Type	Years	Line	
ISB6.7-305	6.7L	408.3	6691cc	OHV Turbo - Intercooled L6	107mm	24	Cummins Eng.	A	MFI/Diesel	2009-2007	7	
6BTA5.9	5.9L	359	5882cc	OHV Turbo - Intercooled L6	102mm	24	Cummins Eng.	6	MFI/Diesel	2005-1998	4	
6BTA5.9	5.9L	359	5882cc	OHV Turbo - Intercooled L6	102mm	24	Cummins Eng.	7	MFI/Diesel	2004-1998	5	
6BTA5.9	5.9L	359	5882cc	OHV Turbo - Intercooled L6	102mm	12	Cummins Eng.	8	MFI/Diesel	1991-1988	1	
6BTA5.9	5.9L	359	5882cc	OHV Turbo - Intercooled L6	102mm	12	Cummins Eng.	C	MFI/Diesel	1996-1991	2	
6BTA5.9	5.9L	359	5882cc	OHV Turbo - Intercooled L6	102mm	24	Cummins Eng.	C	MFI/Diesel	2008-2002	6	
6BTA5.9	5.9L	359	5882cc	OHV Turbo - Intercooled L6	102mm	12	Cummins Eng.	D	MFI/Diesel	1999-1997	3	

5.9L OHV Turbo - Intercooled L6 (12 Valve), 102mm Bore (Cummins Eng.), MFI Diesel Turbo - Intercooled "VIN 8" "Eng. Code 6BTA5.9" 1991-1988					1
QTY	Camshaft	YEARS	PART NO.	DESCRIPTION	
1	Camshaft	91-88	FP-3929042		
QTY	Connecting Rods	YEARS	PART NO.	DESCRIPTION	
12	Con. Rod Bolt	91-88	FP-3900919 *	MJ11 - 1.25 X 59mm	
QTY	Coolers	YEARS	PART NO.	DESCRIPTION	
1	Oil Cooler	91-88	FP-3957544		
QTY	Engine Bearings	YEARS	PART NO.	DESCRIPTION	
1	Cam Brg.	91-88	FP-3901306		
4	Cam Brg.	91-88	FP-3903242 *	Loc. 2-3-4-5; Oversize Bushing	
1	Cam Brg.	91-88	FP-3904369 *	Loc. 1; Oversize Bushing	
12	Rod Bearing Half Upper/Lower	91-88	FP-3901171	.25MM	
12	Rod Bearing Half Upper/Lower	91-88	FP-3901172	.50MM	
12	Rod Bearing Half Upper/Lower	91-88	FP-3901173	.75MM	
12	Rod Bearing Half Upper/Lower	91-88	FP-3901174	1.00MM	
12	Rod Bearing Half Upper/Lower	91-88	FP-3939859	STD	
1	Crankshaft	91-88	FP-3929037	With Gear	
1	Main Set	91-88	FP-3802070	STD	
1	Main Set	91-88	FP-3802071	.25MM	
1	Main Set	91-88	FP-3802072	.50MM	
1	Main Set	91-88	FP-3802073	.75MM	
1	Main Set	91-88	FP-3802074	1.00MM	
QTY	Expansion Plug	YEARS	PART NO.	DESCRIPTION	
4	Expansion Plug	91-88	FP-3007635	Behind pushrod cover; 1.00" Dia.	
1	Expansion Plug	91-88	FP-3900687	Camshaft plug	
12	Expansion Plug	91-88	FP-3907555	Rocker lever support plug	
QTY	Fuel	YEARS	PART NO.	DESCRIPTION	
2	Washer	91-90	FP-3918191	Fuel Injection Pump; 1/2 Inch; .500" I.D., Banjo Connector	
6	Washer	91-88	FP-3900808	Fuel Injector	
2	Washer	89-88	FP-3918191	Fuel Injection Pump; .500" I.D., Banjo Connector	
6	Fuel Injector Seal Ring	91-88	FP-3909356		
6	Fuel Line Connector	91-88	FP-3903380	Fuel Injector; Banjo connector	
1	Solenoid Repair Kit	91-88	FP-3903575	Bosch 12 Volt Fuel Pump	
1	Cover Plate Gasket	91-88	FP-3939258	Fuel transfer pump mounting gasket	
1	Fuel Transfer Pump	91-88	FP-3970880		
2	Washer	89-88	FP-3918191	Fuel Supply Tube; .500" I.D., Banjo Connector	
QTY	Gaskets	YEARS	PART NO.	DESCRIPTION	
1	Oil Cooler Core Inner Gasket	91-88	FP-3926760		
1	Oil Cooler Core Outer Gasket	91-88	FP-3929792		
2	Air Intake Gasket	91-88	FP-3969988		
1	Gear Cover Gasket	91-88	FP-3914385	Timing cover to gear housing	
1	Hydraulic Pump Gasket	91-90	FP-3008400	Hydraulic pump mounting	
1	Gear Housing Gasket	91-88	FP-3938156	Timing gear cover to block	
1	Push Rod Cover Gasket	90-88	FP-3284623		
1	Gasket Conversion Set	91-88	FP-3802376	Incl. seals	
1	Head Gasket	91-88	FP-3283337	.25MM Oversize Thickness	

(continued on next page)

* New Item — Check For Availability

Dodge Truck

1 5.9L OHV Turbo - Intercooled L6 (12 Valve), 102mm Bore (Cummins Eng.), MFI Diesel Turbo - Intercooled				
(cont.) "VIN 8" "Eng. Code 6BTA5.9" 1991-1988				
QTY	Gaskets (cont.)	YEARS	PART NO.	DESCRIPTION
1	Head Gasket	91-88	FP-3283339	.50MM Oversize Thickness
1	Head Gasket	91-88	FP-3283570	Standard Thickness
1	Head Set	91-88	FP-3802245	.50MM Oversize Thickness Head Gasket
1	In-Frame Gasket Set	91-88	FP-3802245S	.50MM Oversize Thickness Head Gasket
1	Head Set	91-88	FP-3802363	Standard Thickness Head Gasket
1	In-Frame Gasket Set	91-88	FP-3802363S	Standard Thickness Head Gasket
1	Head Set	91-88	FP-3802364	.25MM Oversize Thickness Head Gasket
1	In-Frame Gasket Set	91-88	FP-3802364S	.25MM Oversize Thickness Head Gasket
6	Head Bolt	91-88	FP-3920779	M12 x 1.75 x 71.5MM Length
14	Head Bolt	91-88	FP-3920780	M12 x 1.75 x 122MM Length
6	Grommet	91-88	FP-3900267	Push Rod Cover Bolt
1	Fuel Pump Gasket	91-88	FP-3914389	Fuel pump coupling; 3 Hole
2	Grommet	91-88	FP-3900267	Fuel Drain Tube
2	Washer Type Seal	91-88	FP-3903728	Air/Fuel Control Tube Washer
1	Oil Pan Gasket	91-88	FP-3959052	
1	Pick-Up Tube Gasket	91-88	FP-3938157	
1	Rect. or Square Seal	91-88	FP-3903475	Oil Filler Connector
2	Rect. or Square Seal	91-88	FP-3936876	Oil Filler Tube
1	Washer	91-88	FP-3920773	Oil Drain Plug; 18.40MM I.D. x 1.5MM Thick
1	O-Ring	91-90	FP-3909397	Oil Filter Head; Threaded Plug
6	Exhaust Manifold Gasket	91-88	FP-3905443	
1	Int. Manif. Cover Plate Gskt.	91-88	FP-3914029	
6	O-Ring	91-88	FP-3910824	Valve Cover Bolt; .364" I.D. x .070" Thick
1	Redi-Sleeve	91-88	FP-3906080	Engine Crankshaft; Loc. Front
1	Redi-Sleeve	91-88	FP-3906081	Engine Crankshaft; Loc. Rear
1	Oil Seal	91-88	FP-3909410	Engine Crankshaft; Loc. Rear; Dry
1	Oil Seal	91-88	FP-3937111	Engine Crankshaft; Loc. Front
1	Rear Cover Gasket	91-88	FP-3928493	
1	O-Ring	91-88	FP-3923331	Thermostat Housing; Cover
1	O-Ring	91-88	FP-3913994	Timing Cover; Timing Housing Pin O-Ring
1	Turbocharger Mounting Gasket	91-88	FP-3901356	
1	Turbocharger Oil Drain Gasket	91-88	FP-3914388	
6	Valve Cover Gasket	91-88	FP-3930906	
QTY	Lifters	YEARS	PART NO.	DESCRIPTION
12	Lifter	91-88	FP-3931623	Loc. Intake & Exhaust
Lubrication System & Oil Pumps				
QTY	Oil Pumps	YEARS	PART NO.	DESCRIPTION
1	Oil Pump	91-88	FP-4939587	
QTY	Piston Rings	YEARS	PART NO.	DESCRIPTION
6	Ring Set Single Cylinder	91-88	FP-3802230	STD; 1-3.00MM, 1-2.36MM, 1-4.00MM (1 cyl. set)
6	Ring Set Single Cylinder	91-88	FP-3802232	.50mm Oversize; 1-3.00MM, 1-2.36MM, 1-4.00MM (1 cyl. set)
6	Ring Set Single Cylinder	91-88	FP-3802234	1.00mm Oversize; 1-3.00MM, 1-2.36MM, 1-4.00MM (1 cyl. set)
QTY	Pistons	YEARS	PART NO.	DESCRIPTION
6	Piston Body w/o Pin	91-88	FP-3907163	STD
6	Piston Body w/o Pin	91-88	FP-3908815	.50mm Oversize
6	Piston Body w/o Pin	91-88	FP-3908816	1.00mm Oversize
6	Piston w/Retainer & Rings	91-88	FP-3802132	.50mm Oversize
6	Piston w/Retainer & Rings	91-88	FP-3802134	1.00mm Oversize
6	Piston w/Retainer & Rings	91-88	FP-3802160	STD; 17.5:1 C.R.
6	Piston w/Pin, Retainer, Rings	91-88	FP-3802712	STD
6	Piston Kit w/Pin & Retainers	91-88	FP-3907163WP	STD
6	Piston Kit w/Pin & Retainers	91-88	FP-3908815WP	.50MM
6	Piston Kit w/Pin & Retainers	91-88	FP-3908816WP	1.00MM
6	Piston w/Pin, Retainer, Rings	91-88	FP-PK8815	.50MM
6	Piston w/Pin, Retainer, Rings	91-88	FP-PK8816	1.00MM
6	Piston Cooling Nozzle	91-88	FP-3901020	
6	Pin	91-88	FP-3934048	
6	Pin Bushing	91-88	FP-3901085	
12	Piston Pin Retainer	91-88	FP-3920691	
QTY	Push Rods	YEARS	PART NO.	DESCRIPTION
12	Push Rod	91-88	FP-3284377	Loc. Intake & Exhaust; 10.91" O.A.L.
QTY	Rocker Arm Parts	YEARS	PART NO.	DESCRIPTION
6	Rocker Lever Exhaust	91-88	FP-3910810	Loc. Exhaust
6	Rocker Lever Intake	91-88	FP-3910811	Loc. Intake
6	Bolt	91-88	FP-3920781	M12 x 1.75 x 180MM Rocker Arm Bolt
12	Snap Ring	91-88	FP-3900242	Rocker Lever Retaining
12	Washer	91-88	FP-3900245	Rocker Lever; M19
6	Rocker Lever Support	91-88	FP-3922488	

(continued on next page)

Dodge Truck

5.9L OHV Turbo - Intercooled L6 (12 Valve), 102mm Bore (Cummins Eng.), MFI Diesel Turbo - Intercooled 1 "VIN 8" "Eng. Code 6BTA5.9" 1991-1988 (cont.)				
QTY	Part	YEARS	PART NO.	DESCRIPTION
12	Rocker Arm Parts (cont.) Rocker Lever Adjusting Screw	91-88	FP-3937438 *	
6	Sleeves Liner w/o Sealing Ring	91-88	FP-3904166	Standard Bore; To return block to Standard
4	Turbocharger & Connections Turbo Stud	91-88	FP-3818823	Turbocharger mounting studs; M10 x 1.50 x 42MM
2	Hose Clamp	91-88	FP-43828A	Turbocharger; Loc. Oil Drain Tube; 13/16 - 1 1/2 Inch
12	Keeper	91-90	FP-3900250	Loc. Intake & Exhaust
6	Seat	91-88	FP-3904105	Loc. Exhaust
6	Seat	91-88	FP-3906854	Loc. Intake
12	Spring	91-88	FP-3900276	Loc. Intake & Exhaust; 30 PSI
12	Retainer	91-88	FP-3900299	Loc. Intake & Exhaust
12	Valve Stem Seal	91-88	FP-3921640	Loc. Intake & Exhaust
6	Intake Valve Kit	91-88	FP-3802355	Incl. valve & locks
6	Exhaust Valve Kit	91-88	FP-3802356	Incl. valve & locks
12	Guide	91-90	FP-3906206	Loc. Intake & Exhaust; Thin wall; 0.3162" ID, 2.5000" O.A.L
12	Guide	91-88	FP-3904408	Loc. Intake & Exhaust; Thick wall; 0.3160" ID, 2.3970" O.A.L
12	Guide	91-88	FP-3904409	Loc. Intake & Exhaust; Thick wall; 0.3160" ID, 2.0520" O.A.L
1	Water Pumps & Thermostats Water Pump - Heavy Duty	91-88	FP-3286277	
1	Thermostat	91-88	FP-3917324	Vented Thermostat; Double Jiggle Pin Without Notch; 180 Deg. F
1	Water Pump Seal Ring	91-88	FP-3906697	Water Inlet; Rectangular Ring
1	Water Pump Seal Ring	91-88	FP-3906698	Water pump mounting; Rectangular Ring
1	Ball Brg.	91-88	FP-3910739	Fan Pulley
1	Kits In-Frame Overhaul Kit	91-88	FP-6B59PREM	Premium; With Upper Gasket Set & Pan Gasket
1	Complete Overhaul Kit	91-88	FP-6B59PREMOH	Premium; With Front & Rear Seals and Upper & Lower Gasket Sets
5.9L OHV Turbo - Intercooled L6 (12 Valve), 102mm Bore (Cummins Eng.), MFI Diesel Turbo - Intercooled 2 "VIN C" "Eng. Code 6BTA5.9" 1996-1991				
1	Camshaft	96-94	FP-3929734 *	
1	Camshaft	93-91	FP-3929042	
12	Connecting Rods Con. Rod Bolt	96-91	FP-3900919 *	MJ11 - 1.25 X 59mm
1	Coolers Oil Cooler	96-91	FP-3957544	
1	Cylinder Head Fuel Manifold	96-94	FP-3926103	
1	Engine Bearings Cam Brg.	96-91	FP-3901306	
4	Cam Brg.	96-91	FP-3903242 *	Loc. 2-3-4-5; Oversize Bushing
1	Cam Brg.	96-91	FP-3904369 *	Loc. 1; Oversize Bushing
12	Rod Bearing Half Upper/Lower	96-91	FP-3901171	.25MM
12	Rod Bearing Half Upper/Lower	96-91	FP-3901172	.50MM
12	Rod Bearing Half Upper/Lower	96-91	FP-3901173	.75MM
12	Rod Bearing Half Upper/Lower	96-91	FP-3901174	1.00MM
12	Rod Bearing Half Upper/Lower	96-91	FP-3939859	STD
1	Crankshaft	96-91	FP-3929037	With Gear
1	Main Set	96-91	FP-3802070	STD
1	Main Set	96-91	FP-3802071	.25MM
1	Main Set	96-91	FP-3802072	.50MM
1	Main Set	96-91	FP-3802073	.75MM
1	Main Set	96-91	FP-3802074	1.00MM
4	Expansion Plug	96-91	FP-3007635	Behind pushrod cover; 1.00" Dia.
1	Expansion Plug	96-91	FP-3900687	Camshaft plug
12	Expansion Plug	96-91	FP-3907555	Rocker lever support plug
6	Fuel Copper Washer	96-95	FP-3906659	Fuel Injector
2	Washer	96	FP-3918192	Fuel Injection Pump; Overflow Valve
2	Washer	96-94	FP-3918188	Fuel Injection Pump; Check Valve
6	Washer	94	FP-3923261	Fuel Injector
6	Washer	93-91	FP-3900808	Fuel Injector

(continued on next page)

* New Item — Check For Availability

Dodge Truck

2 5.9L OHV Turbo - Intercooled L6 (12 Valve), 102mm Bore (Cummins Eng.), MFI Diesel Turbo - Intercooled (cont.) "VIN C" "Eng. Code 6BTA5.9" 1996-1991

QTY	Fuel (cont.)	YEARS	PART NO.	DESCRIPTION
2	Washer	93-91	FP-3918191	Fuel Injection Pump; 1/2 Inch; .500" I.D., Banjo Connector
6	Fuel Injector Seal Ring	96-91	FP-3909356	
2	Washer	96-95	FP-3918192	Fuel Drain Tube
2	Washer	96-94	FP-3918192	Fuel Supply Tube; Supply Tube to Injection Pump
1	Fuel Transfer Pump	96-94	FP-4944710	183 - 229 LPH; 1/2 x 14 NPTF Fuel Inlet
6	Fuel Line Connector	96-91	FP-3903380	Fuel Injector; Banjo connector
2	Washer	96-91	FP-3918191	Fuel Supply Tube; .500" I.D., Banjo Connector
1	Cover Plate Gasket	96-91	FP-3939258	Fuel transfer pump mounting gasket
1	Solenoid Repair Kit	93-91	FP-3903575	Bosch 12 Volt Fuel Pump
1	Fuel Transfer Pump	93-91	FP-3970880	
QTY	Gaskets	YEARS	PART NO.	DESCRIPTION
1	Oil Cooler Core Inner Gasket	96-91	FP-3926760	
1	Oil Cooler Core Outer Gasket	96-91	FP-3929792	
1	Air Intake Gasket	96-91	FP-3969988	
2	Washer	94-93	FP-3918188	Air/Fuel Control Tube
1	Gear Cover Gasket	96-94	FP-3918673	Timing Cover; Timing cover to gear housing
1	Gear Cover Gasket	93-91	FP-3914385	Timing Cover; Timing cover to gear housing
1	Hydraulic Pump Gasket	96-91	FP-3008400	Hydraulic pump mounting
1	Gear Housing Gasket	96-91	FP-3938156	Timing gear cover to block
1	Push Rod Cover Gasket	96-91	FP-3284623	
1	O-Ring	96	FP-3926047	Cylinder Block; Camshaft rear plug seal
1	Gasket Conversion Set	96-91	FP-3802376	Incl. seals
1	Head Gasket	96-91	FP-3283337	.25MM Oversize Thickness
1	Head Gasket	96-91	FP-3283339	.50MM Oversize Thickness
1	Head Gasket	96-91	FP-3283570	Standard Thickness
1	Head Set	96-91	FP-3802245	.50MM Oversize Thickness Head Gasket
1	In-Frame Gasket Set	96-91	FP-3802245S	.50MM Oversize Thickness Head Gasket
1	Head Set	96-91	FP-3802363	Standard Thickness Head Gasket
1	In-Frame Gasket Set	96-91	FP-3802363S	Standard Thickness Head Gasket
1	Head Set	96-91	FP-3802364	.25MM Oversize Thickness Head Gasket
1	In-Frame Gasket Set	96-91	FP-3802364S	.25MM Oversize Thickness Head Gasket
6	Head Bolt	96-91	FP-3920779	M12 x 1.75 x 71.5MM Length
14	Head Bolt	96-91	FP-3920780	M12 x 1.75 x 122MM Length
2	Grommet	93-91	FP-3900267	Valve Appearance Cover
6	Grommet	96-91	FP-3900267	Push Rod Cover
1	Fuel Pump Gasket	93-91	FP-3914389	Fuel pump coupling; 3 Hole
2	Grommet	94-91	FP-3900267	Fuel Drain Tube
2	Washer Type Seal	92-91	FP-3903728	Air/Fuel Control Tube Washer
1	Oil Pan Gasket	96-91	FP-3959052	
1	Pick-Up Tube Gasket	96-91	FP-3938157	
1	Rect. or Square Seal	96-91	FP-3903475	Oil Filler Connector
2	Rect. or Square Seal	96-91	FP-3936876	Oil Filler Tube; 3.0mm Thick
1	Washer	94	FP-3902425	Oil Drain Plug
1	Washer	93-91	FP-3920773	Oil Drain Plug; 18.40MM I.D. x 1.5MM Thick
1	O-Ring	96-91	FP-3909397	Oil Filter Head; Threaded Plug
6	Exhaust Manifold Gasket	96-91	FP-3905443	
1	Int. Manif. Cover Plate Gskt.	96-91	FP-3914029	
1	O-Ring	96-94	FP-3910260 *	Flywheel Housing Plug
6	O-Ring	96-91	FP-3910824	Valve Cover Bolt; .364" I.D. x .070" Thick
1	Redi-Sleeve	96-91	FP-3906080	Engine Crankshaft; Loc. Front
1	Redi-Sleeve	96-91	FP-3906081	Engine Crankshaft; Loc. Rear
1	Oil Seal	96-91	FP-3909410	Engine Crankshaft; Loc. Rear; Includes Installation Tools; Dry
1	Oil Seal	96-91	FP-3937111	Engine Crankshaft; Loc. Front
1	Rear Cover Gasket	96-91	FP-3928493	0.8mm Thick
1	O-Ring	95-91	FP-3923331	Thermostat Housing; Cover
1	Rect. or Square Seal	96-91	FP-3915772	Timing Cover; Timing Pin Housing; Rectangular Ring Seal
1	O-Ring	96-91	FP-3913994	Timing Cover; Timing Housing Pin O-Ring
1	Turbocharger Mounting Gasket	96-91	FP-3901356	
1	Turbocharger Oil Drain Gasket	96-91	FP-3914388	
1	O-Ring	96-94	FP-3883284	Air Transfer Pipe; For 3.00" Dia. Turbocharger elbow
6	Valve Cover Gasket	96-91	FP-3930906	
QTY	Lifters	YEARS	PART NO.	DESCRIPTION
12	Lifter	96-91	FP-3931623	Loc. Intake & Exhaust
QTY	Lubrication System & Oil Pumps	YEARS	PART NO.	DESCRIPTION
1	Oil Pump	96-91	FP-4939587	
1	Oil Pressure Regulator	96-91	FP-3918428	Oil Press. Regulator Plunger
QTY	Piston Rings	YEARS	PART NO.	DESCRIPTION
6	Ring Set Single Cylinder	96	FP-3802230	215 HP; STD; 1-3.00MM, 1-2.36MM, 1-4.00MM (1 cyl. set)
6	Ring Set Single Cylinder	96	FP-3802232	215 HP; .50mm Oversize; 1-3.00MM, 1-2.36MM, 1-4.00MM (1 cyl. set)

(continued on next page)

* New Item — Check For Availability

5.9L OHV Turbo - Intercooled L6 (12 Valve), 102mm Bore (Cummins Eng.), MFI Diesel Turbo - Intercooled 2
"VIN C" "Eng. Code 6BTA5.9" 1996-1991 (cont.)

QTY	Piston Rings (cont.)	YEARS	PART NO.	DESCRIPTION
6	Ring Set Single Cylinder	96	FP-3802234	215 HP; 1.00mm Oversize; 1-3.00MM, 1-2.36MM, 1-4.00MM (1 cyl. set)
6	Ring Set Single Cylinder	96	FP-3802421	180 HP; STD
6	Ring Set Single Cylinder	96	FP-3802422	180 HP; .50mm Oversize
6	Ring Set Single Cylinder	96	FP-3802423	180 HP; 1.00mm Oversize
6	Ring Set Single Cylinder	95-94	FP-3802421	STD
6	Ring Set Single Cylinder	95-94	FP-3802422	.50mm Oversize
6	Ring Set Single Cylinder	95-94	FP-3802423	1.00mm Oversize
6	Ring Set Single Cylinder	93-91	FP-3802230	STD; 1-3.00MM, 1-2.36MM, 1-4.00MM (1 cyl. set)
6	Ring Set Single Cylinder	93-91	FP-3802232	.50mm Oversize; 1-3.00MM, 1-2.36MM, 1-4.00MM (1 cyl. set)
6	Ring Set Single Cylinder	93-91	FP-3802234	1.00mm Oversize; 1-3.00MM, 1-2.36MM, 1-4.00MM (1 cyl. set)
QTY	Pistons	YEARS	PART NO.	DESCRIPTION
6	Piston Body w/o Pin	96	FP-3922571	180 HP; STD; A Grade; 8 MM Top Ring Land
6	Piston Body w/o Pin	96	FP-3922572	180 HP; STD; B Grade; 8 MM Top Ring Land
6	Piston Body w/o Pin	96	FP-3922573	180 HP; STD; C Grade; 8 MM Top Ring Land
6	Piston Body w/o Pin	96	FP-3922574	180 HP; .50mm Oversize; 8 MM Top Ring Land
6	Piston Body w/o Pin	96	FP-3922575	180 HP; 1.00mm Oversize; 8 MM Top Ring Land
6	Piston Body w/o Pin	96	FP-3926631	215 HP; STD; A Grade; 10 MM Top Ring Land
6	Piston Body w/o Pin	96	FP-3926632	215 HP; STD; B Grade; 10 MM Top Ring Land
6	Piston Body w/o Pin	96	FP-3926633	215 HP; STD; C Grade; 10 MM Top Ring Land
6	Piston Body w/o Pin	96	FP-3926634	215 HP; .50mm Oversize; 10 MM Top Ring Land
6	Piston Body w/o Pin	96	FP-3926635	215 HP; 1.00mm Oversize; 10 MM Top Ring Land
6	Piston Body w/o Pin	95-94	FP-3922571	STD; A Grade; 8 MM Top Ring Land
6	Piston Body w/o Pin	95-94	FP-3922572	STD; B Grade; 8 MM Top Ring Land
6	Piston Body w/o Pin	95-94	FP-3922573	STD; C Grade; 8 MM Top Ring Land
6	Piston Body w/o Pin	95-94	FP-3922574	.50mm Oversize; 8 MM Top Ring Land
6	Piston Body w/o Pin	95-94	FP-3922575	1.00mm Oversize; 8 MM Top Ring Land
6	Piston Body w/o Pin	93-91	FP-3919041	STD
6	Piston Body w/o Pin	93-91	FP-3919044	.50mm Oversize
6	Piston Body w/o Pin	93-91	FP-3919045	1.00mm Oversize
6	Piston w/Retainer & Rings	96	FP-3802487	180 HP; STD; A Grade; 8 MM Top Ring Land
6	Piston w/Retainer & Rings	96	FP-3802489	180 HP; STD; B Grade; 8 MM Top Ring Land
6	Piston w/Retainer & Rings	96	FP-3802490	180 HP; STD; C Grade; 8 MM Top Ring Land
6	Piston w/Retainer & Rings	96	FP-3802493	180 HP; .50mm Oversize; 8 MM Top Ring Land
6	Piston w/Retainer & Rings	96	FP-3802495	180 HP; 1.00mm Oversize; 8 MM Top Ring Land
6	Piston w/Retainer & Rings	96	FP-3802561	215 HP; STD; A Grade; 10 MM Top Ring Land
6	Piston w/Retainer & Rings	96	FP-3802562	215 HP; STD; B Grade; 10 MM Top Ring Land
6	Piston w/Retainer & Rings	96	FP-3802563	215 HP; STD; C Grade; 10 MM Top Ring Land
6	Piston w/Retainer & Rings	96	FP-3802564	215 HP; .50mm Oversize; 10 MM Top Ring Land
6	Piston w/Retainer & Rings	96	FP-3802565	215 HP; 1.00mm Oversize; 10 MM Top Ring Land
6	Piston Kit w/Pin & Retainers	96	FP-3922571WP	180 HP; STD; A Grade; 8 MM Top Ring Land
6	Piston Kit w/Pin & Retainers	96	FP-3922572WP	180 HP; STD; B Grade; 8 MM Top Ring Land
6	Piston Kit w/Pin & Retainers	96	FP-3922573WP	180 HP; STD; C Grade; 8 MM Top Ring Land
6	Piston Kit w/Pin & Retainers	96	FP-3922574WP	180 HP; .50mm Oversize; 8 MM Top Ring Land
6	Piston Kit w/Pin & Retainers	96	FP-3922575WP	180 HP; 1.00mm Oversize; 8 MM Top Ring Land
6	Piston Kit w/Pin & Retainers	96	FP-3926631WP	215 HP; STD; A Grade; 10 MM Top Ring Land
6	Piston Kit w/Pin & Retainers	96	FP-3926632WP	215 HP; STD; B Grade; 10 MM Top Ring Land
6	Piston Kit w/Pin & Retainers	96	FP-3926633WP	215 HP; STD; C Grade; 10 MM Top Ring Land
6	Piston Kit w/Pin & Retainers	96	FP-3926634WP	215 HP; .50mm Oversize; 10 MM Top Ring Land
6	Piston Kit w/Pin & Retainers	96	FP-3926635WP	215 HP; 1.00mm Oversize; 10 MM Top Ring Land
6	Piston w/Pin, Retainer, Rings	96	FP-PK2571	180 HP; STD; A Grade; 8 MM Top Ring Land
6	Piston w/Pin, Retainer, Rings	96	FP-PK2572	180 HP; STD; B Grade; 8 MM Top Ring Land
6	Piston w/Pin, Retainer, Rings	96	FP-PK2573	180 HP; STD; C Grade; 8 MM Top Ring Land
6	Piston w/Pin, Retainer, Rings	96	FP-PK2574	180 HP; .50mm Oversize; 8 MM Top Ring Land
6	Piston w/Pin, Retainer, Rings	96	FP-PK2575	180 HP; 1.00mm Oversize; 8 MM Top Ring Land
6	Piston w/Pin, Retainer, Rings	96	FP-PK6631	215 HP; STD; A Grade; Naturally Aspirated
6	Piston w/Pin, Retainer, Rings	96	FP-PK6632	215 HP; STD; B Grade; 10 MM Top Ring Land
6	Piston w/Pin, Retainer, Rings	96	FP-PK6633	215 HP; STD; C Grade; 10 MM Top Ring Land
6	Piston w/Pin, Retainer, Rings	96	FP-PK6634	215 HP; .50mm Oversize; 10 MM Top Ring Land
6	Piston w/Pin, Retainer, Rings	96	FP-PK6635	215 HP; 1.00mm Oversize; 10 MM Top Ring Land
6	Piston w/Retainer & Rings	95-94	FP-3802487	STD; A Grade; 8 MM Top Ring Land
6	Piston w/Retainer & Rings	95-94	FP-3802489	STD; B Grade; 8 MM Top Ring Land
6	Piston w/Retainer & Rings	95-94	FP-3802490	STD; C Grade; 8 MM Top Ring Land
6	Piston w/Retainer & Rings	95-94	FP-3802493	.50mm Oversize; 8 MM Top Ring Land
6	Piston w/Retainer & Rings	95-94	FP-3802495	1.00mm Oversize; 8 MM Top Ring Land
6	Piston Kit w/Pin & Retainers	95-94	FP-3922571WP	STD; A Grade; 8 MM Top Ring Land
6	Piston Kit w/Pin & Retainers	95-94	FP-3922572WP	STD; B Grade; 8 MM Top Ring Land
6	Piston Kit w/Pin & Retainers	95-94	FP-3922573WP	STD; C Grade; 8 MM Top Ring Land
6	Piston Kit w/Pin & Retainers	95-94	FP-3922574WP	.50mm Oversize; 8 MM Top Ring Land
6	Piston Kit w/Pin & Retainers	95-94	FP-3922575WP	1.00mm Oversize; 8 MM Top Ring Land
6	Piston w/Pin, Retainer, Rings	95-94	FP-PK2571	STD; A Grade; 8 MM Top Ring Land

(continued on next page)

Dodge Truck

2 5.9L OHV Turbo - Intercooled L6 (12 Valve), 102mm Bore (Cummins Eng.), MFI Diesel Turbo - Intercooled				
(cont.) "VIN C" "Eng. Code 6BTA5.9" 1996-1991				
QTY	Pistons (cont.)	YEARS	PART NO.	DESCRIPTION
6	Piston w/Pin, Retainer, Rings	95-94	FP-PK2572	STD; B Grade; 8 MM Top Ring Land
6	Piston w/Pin, Retainer, Rings	95-94	FP-PK2573	STD; C Grade; 8 MM Top Ring Land
6	Piston w/Pin, Retainer, Rings	95-94	FP-PK2574	.50mm Oversize; 8 MM Top Ring Land
6	Piston w/Pin, Retainer, Rings	95-94	FP-PK2575	1.00mm Oversize; 8 MM Top Ring Land
6	Piston w/Retainer & Rings	93-91	FP-3802248	STD; 17.5:1 C.R.
6	Piston w/Retainer & Rings	93-91	FP-3802249	.50mm Oversize
6	Piston w/Retainer & Rings	93-91	FP-3802250	1.00mm Oversize
6	Piston Kit w/Pin & Retainers	93-91	FP-3919041WP	STD
6	Piston Kit w/Pin & Retainers	93-91	FP-3919044WP	.50mm Oversize
6	Piston Kit w/Pin & Retainers	93-91	FP-3919045WP	1.00mm Oversize
6	Piston w/Pin, Retainer, Rings	93-91	FP-PK9041	STD
6	Piston w/Pin, Retainer, Rings	93-91	FP-PK9044	.50mm Oversize
6	Piston w/Pin, Retainer, Rings	93-91	FP-PK9045	1.00mm Oversize
6	Piston Cooling Nozzle	96-91	FP-3937214	
6	Pin	96-91	FP-3934047	
6	Pin Bushing	96-91	FP-3901085	
12	Piston Pin Retainer	96-91	FP-3920691	
QTY	Push Rods	YEARS	PART NO.	DESCRIPTION
12	Push Rod	96-91	FP-3284377	Loc. Intake & Exhaust; 10.91" O.A.L.
QTY	Rocker Arm Parts	YEARS	PART NO.	DESCRIPTION
6	Rocker Lever Exhaust	96-91	FP-3910810	Loc. Exhaust
6	Rocker Lever Intake	96-91	FP-3910811	Loc. Intake
6	Bolt	96-91	FP-3920781	M12 x 1.75 x 180MM Rocker Arm Bolt
12	Adj. Screw Nut	96	FP-3927692	Rocker Lever Nut; 3/8" - 24 UNF
12	Snap Ring	96-91	FP-3900242	Rocker Lever
12	Washer	96-91	FP-3900245	Rocker Lever; M19
6	Rocker Lever Support	96-91	FP-3922488	
12	Rocker Lever Adjusting Screw	96-91	FP-3937438 *	
12	Adj. Screw Nut	95-91	FP-203131	Rocker Lever Nut; 3/8" - 24 UNF
QTY	Sleeves	YEARS	PART NO.	DESCRIPTION
6	Liner w/o Sealing Ring	96-91	FP-3904166	Standard Bore; To return block to Standard
QTY	Timing Components	YEARS	PART NO.	DESCRIPTION
1	Crank Gear	96-91	FP-3929027	
QTY	Turbocharger & Connections	YEARS	PART NO.	DESCRIPTION
4	Turbo Stud	96-91	FP-3818823	Turbocharger mounting studs; M10 x 1.50 x 42MM
2	Hose Clamp	95-91	FP-43828A	Turbocharger; Loc. Oil Drain Tube
QTY	Valve Train Parts	YEARS	PART NO.	DESCRIPTION
12	Keeper	96-91	FP-3900250	Loc. Intake & Exhaust
6	Seat	96-91	FP-3904105	Loc. Exhaust
6	Seat	96-91	FP-3906854	Loc. Intake
12	Spring	96-95	FP-3932453 *	Loc. Intake & Exhaust
12	Spring	94-91	FP-3900276	Loc. Intake & Exhaust; 30 PSI
12	Retainer	96-91	FP-3900299	Loc. Intake & Exhaust
12	Valve Stem Seal	96-91	FP-3921640	Loc. Intake & Exhaust
6	Exhaust	96-91	FP-3920868	Bare Valve
6	Intake Valve Kit	96-91	FP-3802355	Incl. valve & locks
6	Exhaust Valve Kit	96-91	FP-3802356	Incl. valve & locks
6	Intake	96-91	FP-3920867	Bare Valve
6	Guide	96-91	FP-3904408	Loc. Intake; Thick wall; 0.3160" ID, 2.3970" O.A.L
6	Guide	96-91	FP-3904409	Loc. Exhaust; Thick wall; 0.3160" ID, 2.0520" O.A.L
12	Guide	96-91	FP-3906206	Loc. Intake & Exhaust; Thin wall; 0.3162" ID, 2.5000" O.A.L
QTY	Water Pumps & Thermostats	YEARS	PART NO.	DESCRIPTION
1	Water Pump - Heavy Duty	96-93	FP-3286278	
1	Water Pump - Heavy Duty	92-91	FP-3286277	
1	Thermostat	93-91	FP-3917324	180 Deg. F
1	Thermostat Kit	93-91	FP-3802273	180 Deg. F; Includes Thermostat, Template and O-ring
1	Water Pump Seal Ring	96-91	FP-3906697	Water Inlet; Rectangular Ring
1	Water Pump Seal Ring	96-91	FP-3906698	Water pump mounting; Rectangular Ring
1	Ball Brg.	96-91	FP-3910739	Fan Pulley
QTY	Kits	YEARS	PART NO.	DESCRIPTION
1	In-Frame Overhaul Kit	96-91	FP-6B59PREML	Premium; With Upper Gasket Set & Pan Gasket
1	Complete Overhaul Kit	96-91	FP6B5.9PREM-OHL	Premium; With Front & Rear Seals and Upper & Lower Gasket Sets

5.9L OHV Turbo - Intercooled L6 (12 Valve), 102mm Bore (Cummins Eng.), MFI Diesel Turbo - Intercooled 3 "VIN D" "Eng. Code 6BTA5.9" 1999-1997				
QTY	Part Name	YEARS	PART NO.	DESCRIPTION
1	Camshaft	99-97	FP-3929734 *	
12	Connecting Rods Con. Rod Bolt	99-97	FP-3900919 *	MJ11 - 1.25 X 59mm
1	Coolers Oil Cooler	99-97	FP-3957544	
1	Cylinder Head Fuel Manifold	99-97	FP-3926103	
1	Engine Bearings Cam Brg.	99-97	FP-3901306	
4	Cam Brg.	99-97	FP-3903242 *	Loc. 2-3-4-5; Oversize Bushing
1	Cam Brg.	99-97	FP-3904369 *	Loc. 1; Oversize Bushing
12	Rod Bearing Half Upper/Lower	99-97	FP-3901171	.25MM
12	Rod Bearing Half Upper/Lower	99-97	FP-3901172	.50MM
12	Rod Bearing Half Upper/Lower	99-97	FP-3901173	.75MM
12	Rod Bearing Half Upper/Lower	99-97	FP-3901174	1.00MM
12	Rod Bearing Half Upper/Lower	99-97	FP-3939859	STD
1	Crankshaft	99-97	FP-3929037	With Gear
1	Main Set	99-97	FP-3802070	STD
1	Main Set	99-97	FP-3802071	.25MM
1	Main Set	99-97	FP-3802072	.50MM
1	Main Set	99-97	FP-3802073	.75MM
1	Main Set	99-97	FP-3802074	1.00MM
4	Expansion Plug	99-97	FP-3007635	Behind pushrod cover; 1.00" Dia.
1	Expansion Plug	99-97	FP-3900687	Camshaft plug
6	Fuel Copper Washer	99-97	FP-3906659	Fuel Injector
2	Washer	99-97	FP-3918188	Fuel Injection Pump; Check Valve
2	Washer	99-97	FP-3918192	Fuel Injection Pump; Overflow Valve
6	Fuel Injector Seal	99-97	FP-3930324	
6	Fuel Injector Seal Ring	99-97	FP-3909356	
6	Fuel Line Connector	99-97	FP-3903380	Fuel Injector; Banjo connector
2	Washer	99-97	FP-3918191	Fuel Filter Head; Loc. Banjo Connector; .500" I.D., Banjo Connector
2	Washer	99-97	FP-3918191	Fuel Supply Tube; .500" I.D., Banjo Connector
2	Washer	99-97	FP-3918192	Fuel Drain Tube
2	Washer	99-97	FP-3918192	Fuel Supply Tube
2	Cover Plate Gasket	99-97	FP-3939258	Fuel transfer pump mounting gasket
1	Fuel Transfer Pump	99-97	FP-4944710	183 - 229 LPH; 1/2 x 14 NPTF Fuel Inlet
1	Gaskets Oil Cooler Core Inner Gasket	97	FP-3926760	
1	Oil Cooler Core Outer Gasket	99-97	FP-3929792	
2	Air Intake Gasket	99-97	FP-3969988	
1	Gear Cover Gasket	99-97	FP-3918673	Timing Cover; Timing cover to gear housing
1	Hydraulic Pump Gasket	99-97	FP-3008400	Hydraulic pump mounting
1	Gear Housing Gasket	99-97	FP-3938156	Timing gear cover to block
1	Push Rod Cover Gasket	99-97	FP-3284623	
1	O-Ring	99-97	FP-3926047	Cylinder Block; Camshaft rear plug seal
1	Gasket Conversion Set	97	FP-3802376	Incl. seals
1	Head Gasket	99-97	FP-3283337	.25MM Oversize Thickness
1	Head Gasket	99-97	FP-3283339	.50MM Oversize Thickness
1	Head Gasket	99-97	FP-3283570	Standard Thickness
1	Head Set	99-97	FP-3802245	.50MM Oversize Thickness Head Gasket
1	In-Frame Gasket Set	99-97	FP-3802245S	.50MM Oversize Thickness Head Gasket
1	Head Set	99-97	FP-3802363	Standard Thickness Head Gasket
1	In-Frame Gasket Set	99-97	FP-3802363S	Standard Thickness Head Gasket
1	Head Set	99-97	FP-3802364	.25MM Oversize Thickness Head Gasket
1	In-Frame Gasket Set	99-97	FP-3802364S	.25MM Oversize Thickness Head Gasket
6	Head Bolt	99-97	FP-3920779	M12 x 1.75 x 71.5MM Length
14	Head Bolt	99-97	FP-3920780	M12 x 1.75 x 122MM Length
6	Grommet	99-97	FP-3900267	Push Rod Cover
1	Oil Pan Gasket	99-97	FP-3959052	
1	Pick-Up Tube Gasket	99-97	FP-3938157	
1	Rect. or Square Seal	99-97	FP-3903475	Oil Filler Connector
2	Rect. or Square Seal	99-97	FP-3936876	Oil Filler Tube
1	O-Ring	99-97	FP-3929457	Oil Filter Head; Threaded Plug
1	O-Ring	97	FP-3909397	Oil Filter Head; Threaded Plug
6	Exhaust Manifold Gasket	99-97	FP-3905443	
1	Int. Manif. Cover Plate Gskt	99-97	FP-3914029	

(continued on next page)

Dodge Truck

3 5.9L OHV Turbo - Intercooled L6 (12 Valve), 102mm Bore (Cummins Eng.), MFI Diesel Turbo - Intercooled (cont.) "VIN D" "Eng. Code 6BTA5.9" 1999-1997

QTY	Gaskets (cont.)	YEARS	PART NO.	DESCRIPTION
6	O-Ring	99-98	FP-3935449	Valve Cover Bolt
1	O-Ring	97	FP-3910260 *	Flywheel Housing Plug
6	O-Ring	97	FP-3910824	Valve Cover Bolt; Early Eng.s.; .364" I.D. x .070" Thick
6	O-Ring	97	FP-3935449	Valve Cover Bolt; Late Eng.s.
1	Redi-Sleeve	99-97	FP-3906080	Engine Crankshaft; Loc. Front
1	Redi-Sleeve	99-97	FP-3906081	Engine Crankshaft; Loc. Rear
1	Oil Seal	99-97	FP-3909410	Engine Crankshaft; Loc. Rear; Includes Installation Tools; Dry
1	Oil Seal	99-97	FP-3937111	Engine Crankshaft; Loc. Front; Timing Cover Oil Seal
1	Rear Cover Gasket	99-97	FP-3928493	0.8mm Thick
1	Rect. or Square Seal	99-97	FP-3915772	Timing Cover; Timing Pin Housing; Rectangular Ring Seal
1	O-Ring	99-97	FP-3913994	Timing Cover; Timing Housing Pin O-Ring
1	Turbocharger Mounting Gasket	99-97	FP-3901356	
1	Turbocharger Oil Drain Gasket	99-97	FP-3914388	
1	O-Ring	99-97	FP-3883284	Air Transfer Pipe; For 3.00" Dia. Turbocharger elbow
6	Valve Cover Gasket	97	FP-3930906	
QTY	Lifters	YEARS	PART NO.	DESCRIPTION
12	Lifter	99-97	FP-3931623	Loc. Intake & Exhaust
Lubrication System &				
QTY	Oil Pumps	YEARS	PART NO.	DESCRIPTION
1	Oil Pump	99-97	FP-4939587	
1	Oil Pressure Regulator	99-97	FP-3918428	Oil Press. Regulator Plunger
QTY	Piston Rings	YEARS	PART NO.	DESCRIPTION
6	Ring Set Single Cylinder	99-97	FP-3802230	215 HP; STD; 1-3.00MM, 1-2.36MM, 1-4.00MM (1 cyl. set)
6	Ring Set Single Cylinder	99-97	FP-3802232	215 HP; .50mm Oversize; 1-3.00MM, 1-2.36MM, 1-4.00MM (1 cyl. set)
6	Ring Set Single Cylinder	99-97	FP-3802234	215 HP; 1.00mm Oversize; 1-3.00MM, 1-2.36MM, 1-4.00MM (1 cyl. set)
6	Ring Set Single Cylinder	99-97	FP-3802421	180 HP; STD
6	Ring Set Single Cylinder	99-97	FP-3802422	180 HP; .50mm Oversize
6	Ring Set Single Cylinder	99-97	FP-3802423	180 HP; 1.00mm Oversize
QTY	Pistons	YEARS	PART NO.	DESCRIPTION
6	Piston Body w/o Pin	99-97	FP-3922571	180 HP; STD; A Grade; 8 MM Top Ring Land
6	Piston Body w/o Pin	99-97	FP-3922572	180 HP; STD; B Grade; 8 MM Top Ring Land
6	Piston Body w/o Pin	99-97	FP-3922573	180 HP; STD; C Grade; 8 MM Top Ring Land
6	Piston Body w/o Pin	99-97	FP-3922574	180 HP; .50mm Oversize; 8 MM Top Ring Land
6	Piston Body w/o Pin	99-97	FP-3922575	180 HP; 1.00mm Oversize; 8 MM Top Ring Land
6	Piston Body w/o Pin	99-97	FP-3926631	215 HP; STD; A Grade; 10 MM Top Ring Land
6	Piston Body w/o Pin	99-97	FP-3926632	215 HP; STD; B Grade; 10 MM Top Ring Land
6	Piston Body w/o Pin	99-97	FP-3926633	215 HP; STD; C Grade; 10 MM Top Ring Land
6	Piston Body w/o Pin	99-97	FP-3926634	215 HP; .50mm Oversize; 10 MM Top Ring Land
6	Piston Body w/o Pin	99-97	FP-3926635	215 HP; 1.00mm Oversize; 10 MM Top Ring Land
6	Piston w/Retainer & Rings	99-97	FP-3802487	180 HP; STD; A Grade; 8 MM Top Ring Land
6	Piston w/Retainer & Rings	99-97	FP-3802489	180 HP; STD; B Grade; 8 MM Top Ring Land
6	Piston w/Retainer & Rings	99-97	FP-3802490	180 HP; STD; C Grade; 8 MM Top Ring Land
6	Piston w/Retainer & Rings	99-97	FP-3802493	180 HP; .50mm Oversize; 8 MM Top Ring Land
6	Piston w/Retainer & Rings	99-97	FP-3802495	180 HP; 1.00mm Oversize; 8 MM Top Ring Land
6	Piston w/Retainer & Rings	99-97	FP-3802561	215 HP; STD; A Grade; 10 MM Top Ring Land
6	Piston w/Retainer & Rings	99-97	FP-3802562	215 HP; STD; B Grade; 10 MM Top Ring Land
6	Piston w/Retainer & Rings	99-97	FP-3802563	215 HP; STD; C Grade; 10 MM Top Ring Land
6	Piston w/Retainer & Rings	99-97	FP-3802564	215 HP; .50mm Oversize; 10 MM Top Ring Land
6	Piston w/Retainer & Rings	99-97	FP-3802565	215 HP; 1.00mm Oversize; 10 MM Top Ring Land
6	Piston Kit w/Pin & Retainers	99-97	FP-3922571WP	180 HP; STD; A Grade; 8 MM Top Ring Land
6	Piston Kit w/Pin & Retainers	99-97	FP-3922572WP	180 HP; STD; B Grade; 8 MM Top Ring Land
6	Piston Kit w/Pin & Retainers	99-97	FP-3922573WP	180 HP; STD; C Grade; 8 MM Top Ring Land
6	Piston Kit w/Pin & Retainers	99-97	FP-3922574WP	180 HP; .50mm Oversize; 8 MM Top Ring Land
6	Piston Kit w/Pin & Retainers	99-97	FP-3922575WP	180 HP; 1.00mm Oversize; 8 MM Top Ring Land
6	Piston Kit w/Pin & Retainers	99-97	FP-3926631WP	215 HP; STD; A Grade; 10 MM Top Ring Land
6	Piston Kit w/Pin & Retainers	99-97	FP-3926632WP	215 HP; STD; B Grade; 10 MM Top Ring Land
6	Piston Kit w/Pin & Retainers	99-97	FP-3926633WP	215 HP; STD; C Grade; 10 MM Top Ring Land
6	Piston Kit w/Pin & Retainers	99-97	FP-3926634WP	215 HP; .50mm Oversize; 10 MM Top Ring Land
6	Piston Kit w/Pin & Retainers	99-97	FP-3926635WP	215 HP; 1.00mm Oversize; 10 MM Top Ring Land
6	Piston w/Pin, Retainer, Rings	99-97	FP-PK2571	180 HP; STD; A Grade; 8 MM Top Ring Land
6	Piston w/Pin, Retainer, Rings	99-97	FP-PK2572	180 HP; STD; B Grade; 8 MM Top Ring Land
6	Piston w/Pin, Retainer, Rings	99-97	FP-PK2573	180 HP; STD; C Grade; 8 MM Top Ring Land
6	Piston w/Pin, Retainer, Rings	99-97	FP-PK2574	180 HP; .50mm Oversize; 8 MM Top Ring Land
6	Piston w/Pin, Retainer, Rings	99-97	FP-PK2575	180 HP; 1.00mm Oversize; 8 MM Top Ring Land
6	Piston w/Pin, Retainer, Rings	99-97	FP-PK6631	215 HP; STD; A Grade; Naturally Aspirated
6	Piston w/Pin, Retainer, Rings	99-97	FP-PK6632	215 HP; STD; B Grade; 10 MM Top Ring Land
6	Piston w/Pin, Retainer, Rings	99-97	FP-PK6633	215 HP; STD; C Grade; 10 MM Top Ring Land
6	Piston w/Pin, Retainer, Rings	99-97	FP-PK6634	215 HP; .50mm Oversize; 10 MM Top Ring Land
6	Piston w/Pin, Retainer, Rings	99-97	FP-PK6635	215 HP; 1.00mm Oversize; 10 MM Top Ring Land

(continued on next page)

5.9L OHV Turbo - Intercooled L6 (12 Valve), 102mm Bore (Cummins Eng.), MFI Diesel Turbo - Intercooled **3** "VIN D" "Eng. Code 6BTA5.9" 1999-1997 (cont.)

QTY	DESCRIPTION	YEARS	PART NO.	DESCRIPTION
Pistons (cont.)				
6	Piston Cooling Nozzle	99-97	FP-3937214	
6	Pin	99-97	FP-3934047	
6	Pin Bushing	99-97	FP-3901085	
12	Piston Pin Retainer	99-97	FP-3920691	
Push Rods				
12	Push Rod	99-97	FP-3284377	Loc. Intake & Exhaust; 10.91" O.A.L.
Rocker Arm Parts				
6	Rocker Lever Exhaust	99-97	FP-3910810	Loc. Exhaust
6	Rocker Lever Intake	99-97	FP-3910811	Loc. Intake
6	Bolt	99-97	FP-3920781	M12 x 1.75 x 180MM Rocker Arm Bolt
12	Snap Ring	99-97	FP-3900242	Rocker Lever
12	Washer	99-97	FP-3900245	Rocker Lever; M19
6	Rocker Lever Support	99-97	FP-3922488	
12	Adj. Screw Nut	99-97	FP-3927692	Rocker Lever Nut; 3/8 - 24 UNF; 3/8" - 24 UNF
12	Rocker Lever Adjusting Screw	99-97	FP-3937438 *	
Sleeves				
6	Liner w/o Sealing Ring	99-97	FP-3904166	Standard Bore; To return block to Standard
Timing Components				
1	Crank Gear	99-97	FP-3929027	
Turbocharger & Connections				
4	Turbo Stud	99-97	FP-3818823	Turbocharger mounting studs; M10 x 1.50 x 42MM
2	Hose Clamp	99-97	FP-43828A	Turbocharger; Loc. Oil Drain Tube
Valve Train Parts				
12	Keeper	99-97	FP-3900250	Loc. Intake & Exhaust
6	Seat	99-97	FP-3904105	Loc. Exhaust
6	Seat	99-97	FP-3906854	Loc. Intake
12	Spring	99-97	FP-3932453 *	Loc. Intake & Exhaust
12	Retainer	99-97	FP-3900299	Loc. Intake & Exhaust
12	Valve Stem Seal	99-97	FP-3921640	Loc. Intake & Exhaust
6	Exhaust	98-97	FP-3920868	Bare Valve
6	Intake Valve Kit	99-97	FP-3802355	Incl. valve & locks
6	Exhaust Valve Kit	99-97	FP-3802356	Incl. valve & locks
6	Intake	99-97	FP-3920867	Bare Valve
6	Guide	99-97	FP-3904408	Loc. Intake; Thick wall; 0.3160" ID, 2.3970" O.A.L
6	Guide	99-97	FP-3904409	Loc. Exhaust; Thick wall; 0.3160" ID, 2.0520" O.A.L
12	Guide	99-97	FP-3906206	Loc. Intake & Exhaust; Thin wall; 0.3162" ID, 2.5000" O.A.L
Water Pumps & Thermostats				
1	Water Pump - Heavy Duty	99-97	FP-3286277	
1	Water Pump Seal Ring	99-97	FP-3906697	Loc. Water Inlet; Rectangular Ring; Water Inlet; Rectangular Ring
1	Water Pump Seal Ring	99-97	FP-3906698	Water pump mounting; Rectangular Ring
1	Ball Brg.	99-97	FP-3910739	Fan Pulley
Kits				
1	In-Frame Overhaul Kit	99-97	FP-6B59PREML	Premium; With Upper Gasket Set & Pan Gasket
1	Complete Overhaul Kit	99-97	FP6B5.9PREM-OHL	Premium; With Front & Rear Seals and Upper & Lower Gasket Sets

5.9L OHV Turbo - Intercooled L6 (24 Valve), 102mm Bore (Cummins Eng.), MFI Diesel Turbo - Intercooled **4** "VIN 6" "Eng. Code 6BTA5.9" 2005-1998

QTY	DESCRIPTION	YEARS	PART NO.	DESCRIPTION
Connecting Rods				
12	Con. Rod Bolt	03-98	FP-3900919 *	For machine split rods
Coolers				
1	Oil Cooler	02-98	FP-3957544	
Engine Bearings				
1	Cam Brg.	05	FP-3940059	
1	Cam Brg.	04-03	FP-3903242 *	Loc. Intermediate; Oversize
1	Cam Brg.	04-03	FP-3904369 *	Loc. Front; Oversize
2	Cam Brg.	04-03	FP-3940059	
1	Cam Brg.	02-98	FP-3940059	
6	Rod Bearing Half Lower	05-03	FP-4892795	Lower for fracture split rods; .25MM
6	Rod Bearing Half Lower	05-03	FP-4892796	Lower for fracture split rods; .50MM
6	Rod Bearing Half Lower	05-03	FP-4892797	Lower for fracture split rods; .75MM
6	Rod Bearing Half Lower	05-03	FP-4892798	Lower for fracture split rods; 1.00MM
6	Rod Bearing Half Lower	05-03	FP-4893693	Lower for fracture split rods; STD
6	Rod Bearing Half Upper/Lower	05-03	FP-3901171	Upper for fracture split rods; .25MM
6	Rod Bearing Half Upper/Lower	05-03	FP-3901172	Upper for fracture split rods; .50MM
6	Rod Bearing Half Upper/Lower	05-03	FP-3901173	Upper for fracture split rods; .75MM

(continued on next page)

* New Item — Check For Availability

Dodge Truck

4 5.9L OHV Turbo - Intercooled L6 (24 Valve), 102mm Bore (Cummins Eng.), MFI Diesel Turbo - Intercooled (cont.) "VIN 6" "Eng. Code 6BTA5.9" 2005-1998

QTY	Engine Bearings (cont.)	YEARS	PART NO.	DESCRIPTION
6	Rod Bearing Half Upper/Lower	05-03	FP-3901174	Upper for fracture split rods; 1.00MM
6	Rod Bearing Half Upper/Lower	05-03	FP-3939859	Upper for fracture split rods; STD
12	Rod Bearing Half Upper/Lower	03	FP-3901171	Upper/Lower for machine split rods; .25MM
12	Rod Bearing Half Upper/Lower	03	FP-3901172	Upper/Lower for machine split rods; .50MM
12	Rod Bearing Half Upper/Lower	03	FP-3901173	Upper/Lower for machine split rods; .75MM
12	Rod Bearing Half Upper/Lower	03	FP-3901174	Upper/Lower for machine split rods; 1.00MM
12	Rod Bearing Half Upper/Lower	03	FP-3939859	Upper/Lower for machine split rods; STD
12	Rod Bearing Half Upper/Lower	02-98	FP-3901171	.25MM
12	Rod Bearing Half Upper/Lower	02-98	FP-3901172	.50MM
12	Rod Bearing Half Upper/Lower	02-98	FP-3901173	.75MM
12	Rod Bearing Half Upper/Lower	02-98	FP-3901174	1.00MM
12	Rod Bearing Half Upper/Lower	02-98	FP-3939859	STD
6	Rod Pair	05-03	FP-3967060	Upper/Lower for fracture split rods; STD
6	Rod Pair	05-03	FP-3967061	Upper/Lower for fracture split rods; .25MM
6	Rod Pair	05-03	FP-3967062	Upper/Lower for fracture split rods; .50MM
6	Rod Pair	05-03	FP-3967063	Upper/Lower for fracture split rods; .75MM
6	Rod Pair	05-03	FP-3967064	Upper/Lower for fracture split rods; 1.00MM
1	Crankshaft	02	FP-3929037	Option BB9785; With Gear
1	Crankshaft	01	FP-3929037	With Gear
1	Main Set	05	FP-3357480	STD
1	Main Set	05-98	FP-3802070	STD
1	Main Set	05-98	FP-3802071	.25MM
1	Main Set	05-98	FP-3802072	.50MM
1	Main Set	05-98	FP-3802073	.75MM
1	Main Set	05-98	FP-3802074	1.00MM
QTY	Engine Oil Seals	YEARS	PART NO.	DESCRIPTION
1	Oil Seal Kit	05-99	FP-3804899	Engine Timing Cover; Timing Cover Oil Seal; Includes Installation Tools & Debris shield
QTY	Expansion Plug	YEARS	PART NO.	DESCRIPTION
14	Expansion Plug	04-98	FP-3007635	Cyl. head; 1.00" Dia.
4	Expansion Plug	02-98	FP-3007635	Behind pushrod cover; 1.00" Dia.
1	Expansion Plug	02-98	FP-3900687	Camshaft plug
QTY	Fuel	YEARS	PART NO.	DESCRIPTION
6	Fuel Injector Washer	05-02	FP-3937142	Fuel Injector Seal
6	Copper Washer	01-99	FP-3906659	Fuel Injector
1	Electric Fuel Pump	04	FP-4089602	Option FF9492
1	Electric Fuel Pump	02-98	FP-3990105	Fuel Transfer Pump
7	Oil Seal	05-04	FP-3963983	Fuel Drain Tube; M12
1	Cover Plate Gasket	05-03	FP-3939258	Fuel Transfer Pump
4	Oil Seal	05-01	FP-3963983	Fuel Supply Tube; M12
2	Oil Seal	05-00	FP-3963988	Fuel Drain Tube; M14
2	Washer	99-98	FP-3918191	Fuel Drain Tube; .500" I.D., Banjo Connector
8	Washer	99-98	FP-3918191	Fuel Supply Tube; .500" I.D., Banjo Connector
2	Washer	99-98	FP-3918191	Fuel Supply Tube; Loc. Fuel Pump; .500" I.D., Banjo Connector
2	Washer	99-98	FP-3918192	Fuel Drain Tube
QTY	Gaskets	YEARS	PART NO.	DESCRIPTION
1	Oil Cooler Core Inner Gasket	02-98	FP-3926760	
2	Air Intake Gasket	05-98	FP-3969988	
1	Hydraulic Pump Gasket	01-98	FP-3008400	Hydraulic pump mounting
1	Gear Housing Gasket	02-98	FP-3938156	Timing gear cover to block
1	Push Rod Cover Gasket	02-98	FP-3284623	
1	Accessory Drive Gasket	02	FP-3938655 *	Vacuum pump mounting gasket
1	O-Ring	05	FP-3678912	Cylinder Block; For use with 3680419 Threaded Plug
1	O-Ring	05	FP-3679139	Cylinder Block; For use with 3089568 Threaded Plug
1	O-Ring	05-04	FP-3678786	Cylinder Block; For use with 3678791 Threaded Plug
2	O-Ring	05-98	FP-3678925	Cylinder Block; For use with 3678924 Threaded Plug; M10 x 1.00
1	O-Ring	04-03	FP-3678912	Cylinder Block
1	O-Ring	04-03	FP-3679139	Cylinder Block; For use with 3089567 Threaded Plug
1	O-Ring	03	FP-3678786	Cylinder Block; For use with 36778791 Threaded Plug
1	O-Ring	03	FP-3946689 *	Access Hole Cover Seal
1	O-Ring	02-98	FP-3926047	Cylinder Block; Camshaft rear plug seal
1	Gasket Conversion Set	04-03	FP-4089173 *	Lower set
1	Gasket Conversion Set	02-00	FP-3800833 *	
1	Gasket Conversion Set	99-98	FP-3800487 *	
1	Head Gasket	04	FP-3958644 *	A Grade; 1.18mm Thick
1	Head Gasket	04-03	FP-3958645 *	B Grade; 1.25mm Thick
1	Head Gasket	02-98	FP-3977063	.061" Thickness
1	Head Set	04-03	FP-4089819 *	Upper set
1	Head Set	02-00	FP-4090037 *	.061" Thickness Head Gasket
1	Head Set	99-98	FP-4090035	.061" Thickness Head Gasket

(continued on next page)

* New Item — Check For Availability

5.9L OHV Turbo - Intercooled L6 (24 Valve), 102mm Bore (Cummins Eng.), MFI Diesel Turbo - Intercooled 4
"VIN 6" "Eng. Code 6BTA5.9" 2005-1998 (cont.)

QTY	Gaskets (cont.)	YEARS	PART NO.	DESCRIPTION
26	Head Bolt	05-98	FP-3927063	M12 x 1.75 x 131MM Length
6	Grommet	02-98	FP-3928759	Push Rod Cover
1	O-Ring	04	FP-3010937	Fuel Transfer Pump; Fuel Transfer Pump to Fuel Filter
1	O-Ring	03	FP-3916284	Fuel Transfer Pump; Fuel Transfer Pump to Fuel Filter; Use with pump no. 3957784
1	O-Ring	05-03	FP-3949688	Fuel Pump Mounting
1	O-Ring	00	FP-3935032	Fuel Pump Mounting; For Bosch VP44 Pump
1	O-Ring	99-98	FP-3910503	Fuel Pump Mounting; For Bosch VP44 Pump
6	O-Ring	02-98	FP-3867043	Fuel Injection; Fuel Injector Supply Tube
1	Oil Filter Head Gasket	02-98	FP-3942915	
1	Oil Suction Tube Gasket	05-03	FP-3949562	
1	Oil Pan Gasket	05-03	FP-3958165	
1	Oil Pan Gasket	02-98	FP-3959052	
1	Pick-Up Tube Gasket	02-98	FP-3938157	
1	Rect. or Square Seal	02-98	FP-3903475	Crankcase Breather; Loc. To Front Cover
1	O-Ring	05-04	FP-3946188	Oil Dipstick
2	O-Ring	05-00	FP-3946188	Oil Dipstick Tube
1	O-Ring	02	FP-3946188	Oil Drain Tube
1	O-Ring	05	FP-3929457	Oil Filter Head; For use with 3946947 Threaded plug
1	O-Ring	04-98	FP-3929457	Oil Filter Head; Threaded Plug
6	Exhaust Manifold Gasket	04-98	FP-3946275	
1	Intake Manifold Gasket	02	FP-3938152	Manifold Cover
1	Int. Manif. Cover Plate Gskt.	01-98	FP-3914029	
1	O-Ring	05-04	FP-3957440	Temperature/Pressure Sensor; Loc. Intake Manifold
1	O-Ring	05-03	FP-3073966	Valve Cover; Crankcase Breather
1	O-Ring	03	FP-3957440	Position Sensor
1	O-Ring	02-98	FP-3678912	Temperature Sensor; Air Temperature
1	O-Ring	02-98	FP-3678912	Temperature Sensor; Water Temperature
1	O-Ring	02-98	FP-3910260 *	Flywheel Housing Plug
1	Oil Seal	03-98	FP-3937111	Engine Crankshaft; Loc. Front
1	Oil Seal	99-98	FP-3909410	Engine Crankshaft; Loc. Rear; Includes Installation Tools; Dry
1	Oil Seal Kit	05-04	FP-4089342	Engine Crankshaft; Loc. Rear; Includes Installation Tools
1	Oil Seal Kit	05-98	FP-3802820	Engine Crankshaft; Loc. Front; Incl. wear sleeve
1	Oil Seal Kit	05-98	FP-3926126	Engine Crankshaft; Loc. Rear
1	Rear Cover Gasket	02-98	FP-3928493	0.8mm Thick
1	O-Ring	03	FP-3946689 *	Access Hole Cover Seal
1	Rect. or Square Seal	02-99	FP-3942454	Thermostat
1	Turbocharger Mounting Gasket	02-98	FP-3901356	
1	Turbocharger Gasket	02-00	FP-3709861	Mounting; Holset part number equivalent
1	O-Ring	05	FP-3922794	Turbocharger
2	O-Ring	05-98	FP-3922794	Turbocharger; Flexible Hose
1	O-Ring	03-98	FP-3931824	Turbocharger; Loc. Oil Drain Tube
1	O-Ring	02-98	FP-3883284	Air Transfer Pipe; For 3.00" Dia. Turbocharger elbow
1	Valve Cover Gasket	02-98	FP-3935878	
QTY	Lifters	YEARS	PART NO.	DESCRIPTION
24	Lifter	05-03	FP-3947759 *	Loc. Intake & Exhaust
24	Lifter	02-98	FP-3942565	Loc. Intake & Exhaust
QTY	Lubrication System & Oil Pumps	YEARS	PART NO.	DESCRIPTION
1	Oil Pump	02-98	FP-4939587	
1	Oil Pressure Regulator	02-98	FP-3918428	Oil Press. Regulator Plunger
QTY	Piston Rings	YEARS	PART NO.	DESCRIPTION
6	Ring Set Single Cylinder	05-03	FP-4089181	.50mm Oversize
6	Ring Set Single Cylinder	05-03	FP-4089182	1.00mm Oversize
6	Ring Set Single Cylinder	05-03	FP-4089258	STD
6	Ring Set Single Cylinder	02-98	FP-3804990	STD
6	Ring Set Single Cylinder	02-98	FP-3806201	.50mm Oversize
6	Ring Set Single Cylinder	02-98	FP-3806203	1.00mm Oversize
QTY	Pistons	YEARS	PART NO.	DESCRIPTION
6	Piston Body w/o Pin	05	FP-3949843	.50mm Oversize
6	Piston Body w/o Pin	05	FP-3949844	1.00mm Oversize
6	Piston Body w/o Pin	05	FP-3958675	STD
6	Piston Body w/o Pin	04	FP-3949843	CPL 8412, 98328; .50mm Oversize
6	Piston Body w/o Pin	04	FP-3949844	CPL 8412, 98328; 1.00mm Oversize
6	Piston Body w/o Pin	04	FP-3958675	CPL 8412, 98328; STD
6	Piston Body w/o Pin	03	FP-3949843	CPL 2624, 8223, 8224, 8410, 98293; .50mm Oversize
6	Piston Body w/o Pin	03	FP-3949844	CPL 2624, 8223, 8224, 8410, 98293; 1.00mm Oversize
6	Piston Body w/o Pin	03	FP-3958675	CPL 2624, 8223, 8224, 8410, 98293; STD
6	Piston Body w/o Pin	02	FP-3946050 *	CPL 2907, 8034, 8035; STD; A Grade
6	Piston Body w/o Pin	02	FP-3946051 *	CPL 2907, 8034, 8035; STD; B Grade

(continued on next page)

* New Item — Check For Availability

Dodge Truck

4 5.9L OHV Turbo - Intercooled L6 (24 Valve), 102mm Bore (Cummins Eng.), MFI Diesel Turbo - Intercooled (cont.) "VIN 6" "Eng. Code 6BTA5.9" 2005-1998

QTY	Pistons (cont.)	YEARS	PART NO.	DESCRIPTION
6	Piston Body w/o Pin	02	FP-3946052 *	CPL 2907, 8034, 8035; STD; C Grade
6	Piston Body w/o Pin	02	FP-3946053 *	CPL 2907, 8034, 8035; .50mm Oversize
6	Piston Body w/o Pin	02	FP-3946054 *	CPL 2907, 8034, 8035; 1.00mm Oversize
6	Piston Body w/o Pin	02	FP-3946153	CPL 2902, 2903, 2904, 8030, 8031, 8032, 8033; STD; A Grade
6	Piston Body w/o Pin	02	FP-3946154	CPL 2902, 2903, 2904, 8030, 8031, 8032, 8033; STD; B Grade
6	Piston Body w/o Pin	02	FP-3946155	CPL 2902, 2903, 2904, 8030, 8031, 8032, 8033; STD; C Grade
6	Piston Body w/o Pin	02	FP-3946156	CPL 2902, 2903, 2904, 8030, 8031, 8032, 8033; .50mm Oversize
6	Piston Body w/o Pin	02	FP-3946157	CPL 2902, 2903, 2904, 8030, 8031, 8032, 8033; 1.00mm Oversize
6	Piston Body w/o Pin	01	FP-3946050 *	CPL 2906, 2907, 2415, 2495; STD; A Grade
6	Piston Body w/o Pin	01	FP-3946051 *	CPL 2906, 2907, 2415, 2495; STD; B Grade
6	Piston Body w/o Pin	01	FP-3946052 *	CPL 2906, 2907, 2415, 2495; STD; C Grade
6	Piston Body w/o Pin	01	FP-3946053 *	CPL 2906, 2907, 2415, 2495; .50mm Oversize
6	Piston Body w/o Pin	01	FP-3946054 *	CPL 2906, 2907, 2415, 2495; 1.00mm Oversize
6	Piston Body w/o Pin	01	FP-3946153	CPL 2496, 2497, 2865, 2866, 2902, 2903, 2904, 2905; STD; A Grade
6	Piston Body w/o Pin	01	FP-3946154	CPL 2496, 2497, 2865, 2866, 2902, 2903, 2904, 2905; STD; B Grade
6	Piston Body w/o Pin	01	FP-3946155	CPL 2496, 2497, 2865, 2866, 2902, 2903, 2904, 2905; STD; C Grade
6	Piston Body w/o Pin	01	FP-3946156	CPL 2496, 2497, 2865, 2866, 2902, 2903, 2904, 2905; .50mm Oversize
6	Piston Body w/o Pin	01	FP-3946157	CPL 2496, 2497, 2865, 2866, 2902, 2903, 2904, 2905; 1.00mm Oversize
6	Piston Body w/o Pin	00-98	FP-3946153	CPL 2098, 2280, 2497, 2513, 2515, 2617, 2619, 2660, 2661, 2663; STD; A Grade
6	Piston Body w/o Pin	00-98	FP-3946154	CPL 2098, 2280, 2497, 2513, 2515, 2617, 2619, 2660, 2661, 2663; STD; B Grade
6	Piston Body w/o Pin	00-98	FP-3946155	CPL 2098, 2280, 2497, 2513, 2515, 2617, 2619, 2660, 2661, 2663; STD; C Grade
6	Piston Body w/o Pin	00-98	FP-3946156	CPL 2098, 2280, 2497, 2513, 2515, 2617, 2619, 2660, 2661, 2663; .50mm Oversize
6	Piston Body w/o Pin	00-98	FP-3946157	CPL 2098, 2280, 2497, 2513, 2515, 2617, 2619, 2660, 2661, 2663; 1.00mm Oversize
6	Piston w/Retainer & Rings	04	FP-4089185	CPL 8412, 98328; .50mm Oversize
6	Piston w/Retainer & Rings	04	FP-4089186	CPL 8412, 98328; 1.00mm Oversize
6	Piston w/Retainer & Rings	04	FP-4089260	CPL 8412, 98328; STD
6	Piston w/Pin, Retainer, Rings	04	FP-PK9185	CPL 8412, 98328; .50mm Oversize
6	Piston w/Pin, Retainer, Rings	04	FP-PK9186	CPL 8412, 98328; 1.00mm Oversize
6	Piston w/Pin, Retainer, Rings	04	FP-PK9260	CPL 8412, 98328; STD
6	Piston w/Retainer & Rings	03	FP-4089185	CPL 2624, 8223, 8224, 8410, 98293; .50mm Oversize
6	Piston w/Retainer & Rings	03	FP-4089186	CPL 2624, 8223, 8224, 8410, 98293; 1.00mm Oversize
6	Piston w/Retainer & Rings	03	FP-4089260	CPL 2624, 8223, 8224, 8410, 98293; STD
6	Piston w/Pin, Retainer, Rings	03	FP-PK9185	CPL 2624, 8223, 8224, 8410, 98293; .50mm Oversize
6	Piston w/Pin, Retainer, Rings	03	FP-PK9186	CPL 2624, 8223, 8224, 8410, 98293; 1.00mm Oversize
6	Piston w/Pin, Retainer, Rings	03	FP-PK9260	CPL 2624, 8223, 8224, 8410, 98293; STD
6	Piston w/Retainer & Rings	02	FP-3800781	CPL 2902, 2903, 2904, 8030, 8031, 8032, 8033; STD; A Grade
6	Piston w/Retainer & Rings	02	FP-3800782	CPL 2902, 2903, 2904, 8030, 8031, 8032, 8033; STD; B Grade
6	Piston w/Retainer & Rings	02	FP-3800783	CPL 2902, 2903, 2904, 8030, 8031, 8032, 8033; STD; C Grade
6	Piston w/Retainer & Rings	02	FP-3800784	CPL 2902, 2903, 2904, 8030, 8031, 8032, 8033; .50mm Oversize
6	Piston w/Retainer & Rings	02	FP-3800785	CPL 2902, 2903, 2904, 8030, 8031, 8032, 8033; 1.00mm Oversize
6	Piston w/Retainer & Rings	02	FP-3800838	CPL 2907, 8034, 8035; STD; A Grade
6	Piston w/Retainer & Rings	02	FP-3800839	CPL 2907, 8034, 8035; STD; B Grade
6	Piston w/Retainer & Rings	02	FP-3800840	CPL 2907, 8034, 8035; STD; C Grade
6	Piston w/Retainer & Rings	02	FP-3800841	CPL 2907, 8034, 8035; .50mm Oversize
6	Piston w/Retainer & Rings	02	FP-3800842	CPL 2907, 8034, 8035; 1.00mm Oversize
6	Piston w/Pin, Retainer, Rings	02	FP-PK0781	CPL 2902, 2903, 2904, 8030, 8031, 8032, 8033; STD; A Grade
6	Piston w/Pin, Retainer, Rings	02	FP-PK0782	CPL 2902, 2903, 2904, 8030, 8031, 8032, 8033; STD; B Grade
6	Piston w/Pin, Retainer, Rings	02	FP-PK0783	CPL 2902, 2903, 2904, 8030, 8031, 8032, 8033; STD; C Grade
6	Piston w/Pin, Retainer, Rings	02	FP-PK0784	CPL 2902, 2903, 2904, 8030, 8031, 8032, 8033; .50mm Oversize
6	Piston w/Pin, Retainer, Rings	02	FP-PK0785	CPL 2902, 2903, 2904, 8030, 8031, 8032, 8033; 1.00mm Oversize
6	Piston w/Pin, Retainer, Rings	02	FP-PK0838	CPL 2907, 8034, 8035; STD; A Grade
6	Piston w/Pin, Retainer, Rings	02	FP-PK0839	CPL 2907, 8034, 8035; STD; B Grade
6	Piston w/Pin, Retainer, Rings	02	FP-PK0840	CPL 2907, 8034, 8035; STD; C Grade
6	Piston w/Pin, Retainer, Rings	02	FP-PK0841	CPL 2907, 8034, 8035; .50mm Oversize
6	Piston w/Pin, Retainer, Rings	02	FP-PK0842	CPL 2907, 8034, 8035; 1.00mm Oversize
6	Piston w/Retainer & Rings	01	FP-3800781	CPL 2496, 2497, 2865, 2866, 2902, 2903, 2904, 2905; STD; A Grade
6	Piston w/Retainer & Rings	01	FP-3800782	CPL 2496, 2497, 2865, 2866, 2902, 2903, 2904, 2905; STD; B Grade
6	Piston w/Retainer & Rings	01	FP-3800783	CPL 2496, 2497, 2865, 2866, 2902, 2903, 2904, 2905; STD; C Grade
6	Piston w/Retainer & Rings	01	FP-3800784	CPL 2496, 2497, 2865, 2866, 2902, 2903, 2904, 2905; .50mm Oversize
6	Piston w/Retainer & Rings	01	FP-3800785	CPL 2496, 2497, 2865, 2866, 2902, 2903, 2904, 2905; 1.00mm Oversize
6	Piston w/Retainer & Rings	01	FP-3800838	CPL 2906, 2907, 2415, 2495; STD; A Grade
6	Piston w/Retainer & Rings	01	FP-3800839	CPL 2906, 2907, 2415, 2495; STD; B Grade
6	Piston w/Retainer & Rings	01	FP-3800840	CPL 2906, 2907, 2415, 2495; STD; C Grade

(continued on next page)

* New Item — Check For Availability

5.9L OHV Turbo - Intercooled L6 (24 Valve), 102mm Bore (Cummins Eng.), MFI Diesel Turbo - Intercooled 4
"VIN 6" "Eng. Code 6BTA5.9" 2005-1998 (cont.)

QTY	Pistons (cont.)	YEARS	PART NO.	DESCRIPTION
6	Piston w/Retainer & Rings	01	FP-3800841	CPL 2906, 2907, 2415, 2495; .50mm Oversize
6	Piston w/Retainer & Rings	01	FP-3800842	CPL 2906, 2907, 2415, 2495; 1.00mm Oversize
6	Piston w/Pin, Retainer, Rings	01	FP-PK0781	CPL 2496, 2497, 2865, 2866, 2902, 2903, 2904, 2905; STD; A Grade
6	Piston w/Pin, Retainer, Rings	01	FP-PK0782	CPL 2496, 2497, 2865, 2866, 2902, 2903, 2904, 2905; STD; B Grade
6	Piston w/Pin, Retainer, Rings	01	FP-PK0783	CPL 2496, 2497, 2865, 2866, 2902, 2903, 2904, 2905; STD; C Grade
6	Piston w/Pin, Retainer, Rings	01	FP-PK0784	CPL 2496, 2497, 2865, 2866, 2902, 2903, 2904, 2905; .50mm Oversize
6	Piston w/Pin, Retainer, Rings	01	FP-PK0785	CPL 2496, 2497, 2865, 2866, 2902, 2903, 2904, 2905; 1.00mm Oversize
6	Piston w/Retainer & Rings	00-98	FP-3800781	CPL 2098, 2280, 2497, 2513, 2515, 2617, 2619, 2660, 2661, 2663; STD; A Grade
6	Piston w/Retainer & Rings	00-98	FP-3800782	CPL 2098, 2280, 2497, 2513, 2515, 2617, 2619, 2660, 2661, 2663; STD; B Grade
6	Piston w/Retainer & Rings	00-98	FP-3800783	CPL 2098, 2280, 2497, 2513, 2515, 2617, 2619, 2660, 2661, 2663; STD; C Grade
6	Piston w/Retainer & Rings	00-98	FP-3800784	CPL 2098, 2280, 2497, 2513, 2515, 2617, 2619, 2660, 2661, 2663; .50mm Oversize
6	Piston w/Retainer & Rings	00-98	FP-3800785	CPL 2098, 2280, 2497, 2513, 2515, 2617, 2619, 2660, 2661, 2663; 1.00mm Oversize
6	Piston w/Pin, Retainer, Rings	99-98	FP-PK0781	CPL 2098, 2280, 2497, 2513, 2515, 2617, 2619, 2660, 2661, 2663; STD; A Grade
6	Piston w/Pin, Retainer, Rings	99-98	FP-PK0782	CPL 2098, 2280, 2497, 2513, 2515, 2617, 2619, 2660, 2661, 2663; STD; B Grade
6	Piston w/Pin, Retainer, Rings	99-98	FP-PK0783	CPL 2098, 2280, 2497, 2513, 2515, 2617, 2619, 2660, 2661, 2663; STD; C Grade
6	Piston w/Pin, Retainer, Rings	99-98	FP-PK0784	CPL 2098, 2280, 2497, 2513, 2515, 2617, 2619, 2660, 2661, 2663; .50mm Oversize
6	Piston w/Pin, Retainer, Rings	99-98	FP-PK0785	CPL 2098, 2280, 2497, 2513, 2515, 2617, 2619, 2660, 2661, 2663; 1.00mm Oversize
6	Piston Cooling Nozzle	04	FP-3937214	CPL 8412, 98328
6	Piston Cooling Nozzle	03	FP-3937214	CPL 2624, 8223, 8224, 8410, 98293
6	Piston Cooling Nozzle	02-98	FP-3937214	
6	Pin	05-98	FP-3934047	
6	Pin Bushing	05-98	FP-4891178	
12	Piston Pin Retainer	05-98	FP-3920691	
QTY Rocker Arm Parts YEARS PART NO. DESCRIPTION				
24	Adj. Screw Nut	05-02	FP-3927692	Rocker Lever Nut; 3/8" - 24 UNF
24	Adj. Screw Nut	01-98	FP-203131	Rocker Lever Nut; 3/8" - 24 UNF
QTY Sleeves YEARS PART NO. DESCRIPTION				
6	Liner w/o Sealing Ring	05-98	FP-3904166	Standard Bore; To return block to Standard
QTY Timing Components YEARS PART NO. DESCRIPTION				
1	Crank Gear	02-98	FP-3929027	
QTY Turbocharger & Connections YEARS PART NO. DESCRIPTION				
4	Turbo Stud	04-98	FP-3818823	Turbocharger mounting studs; M10 x 1.50 x 42MM
1	Oil Drain Gasket	02-01	FP-3937706	Turbocharger oil drain gasket
1	Turbocharger Oil Drain Gasket	00	FP-3914388	Turbocharger
1	Drain Gasket	00-98	FP-3942725	Turbocharger; Turbocharger oil drain gasket
QTY Valve Train Parts YEARS PART NO. DESCRIPTION				
48	Keeper	05-98	FP-3940123	Loc. Intake & Exhaust
5	Isolator, Rocker Cover Bolt	02-00	FP-3946168 *	
5	Isolator, Rocker Cover Bolt	99-98	FP-3942659	
24	Spring Cap	05-98	FP-3943198	Loc. Intake & Exhaust
24	Spring	05-98	FP-4936080	Loc. Intake & Exhaust
12	Valve Stem Seal	05-03	FP-3955393	Loc. Intake
12	Valve Stem Seal	05-03	FP-3955394	Loc. Exhaust
12	Valve Stem Seal	02-98	FP-3942989	Loc. Intake; Color Yellow
12	Valve Stem Seal	02-98	FP-3945438	Loc. Exhaust; Color Green
12	Exhaust	04-98	FP-3940734	Chrome plated stem; 1.299" Head Dia., .02756" Stem Dia., 4.893" O.A.L.
12	Intake Valve Kit	05-98	FP-3802924	Incl. valve & keeper; 1.2990" Head Dia., .2756" Stem Dia., 4.9070" O.A.L.
12	Intake	05-98	FP-3940735	Chrome plated stem; 1.299" Head Dia., .02756" Stem Dia., 4.907" O.A.L.
12	Exhaust Valve Kit	04-98	FP-3802967	Incl. valve & keeper; 1.2990" Head Dia., .2756" Stem Dia., 4.8930" O.A.L.
QTY Water Pumps & Thermostats YEARS PART NO. DESCRIPTION				
1	Water Pump - Heavy Duty	02-98	FP-3286278	
1	Water Pump Seal Ring	05-98	FP-3906697	Loc. Water Inlet; Rectangular Ring; Water Inlet; Rectangular Ring

(continued on next page)

* New Item — Check For Availability

Dodge Truck

4 5.9L OHV Turbo - Intercooled L6 (24 Valve), 102mm Bore (Cummins Eng.), MFI Diesel Turbo - Intercooled (cont.) "VIN 6" "Eng. Code 6BTA5.9" 2005-1998				
QTY	Water Pumps & Thermostats (cont.)	YEARS	PART NO.	DESCRIPTION
1	Water Pump Seal Ring	05-98	FP-3906698	Water pump mounting; Rectangular Ring
1	Ball Brg.	05-98	FP-3910739	Fan Pulley
QTY	Kits	YEARS	PART NO.	DESCRIPTION
1	In-Frame Overhaul Kit	99-98	FP-IFKISB624V	From 1998.5 to 2006
5 5.9L OHV Turbo - Intercooled L6 (24 Valve), 102mm Bore (Cummins Eng.), MFI Diesel Turbo - Intercooled "VIN 7" "Eng. Code 6BTA5.9" 2004-1998				
QTY	Connecting Rods	YEARS	PART NO.	DESCRIPTION
12	Con. Rod Bolt	03	FP-3900919 *	For machine split rods
12	Con. Rod Bolt	02-98	FP-3900919 *	
QTY	Coolers	YEARS	PART NO.	DESCRIPTION
1	Oil Cooler	02-98	FP-3957544	
QTY	Engine Bearings	YEARS	PART NO.	DESCRIPTION
2	Cam Brg.	04-03	FP-3940059	
1	Cam Brg.	04-98	FP-3903242 *	Loc. Intermediate; Oversize
1	Cam Brg.	04-98	FP-3904369 *	Loc. Front; Oversize
1	Cam Brg.	02-98	FP-3940059	
6	Rod Bearing Half Lower	04-03	FP-4892795	Lower for fracture split rods; .25MM
6	Rod Bearing Half Lower	04-03	FP-4892796	Lower for fracture split rods; .50MM
6	Rod Bearing Half Lower	04-03	FP-4892797	Lower for fracture split rods; .75MM
6	Rod Bearing Half Lower	04-03	FP-4892798	Lower for fracture split rods; 1.00MM
6	Rod Bearing Half Lower	04-03	FP-4893693	Lower for fracture split rods; STD
6	Rod Bearing Half Upper/Lower	04-03	FP-3901171	Upper for fracture split rods; .25MM
6	Rod Bearing Half Upper/Lower	04-03	FP-3901172	Upper for fracture split rods; .50MM
6	Rod Bearing Half Upper/Lower	04-03	FP-3901173	Upper for fracture split rods; .75MM
6	Rod Bearing Half Upper/Lower	04-03	FP-3901174	Upper for fracture split rods; 1.00MM
6	Rod Bearing Half Upper/Lower	04-03	FP-3939859	Upper for fracture split rods; STD
12	Rod Bearing Half Upper/Lower	03	FP-3901171	Upper/Lower for machine split rods; .25MM
12	Rod Bearing Half Upper/Lower	03	FP-3901172	Upper/Lower for machine split rods; .50MM
12	Rod Bearing Half Upper/Lower	03	FP-3901173	Upper/Lower for machine split rods; .75MM
12	Rod Bearing Half Upper/Lower	03	FP-3901174	Upper/Lower for machine split rods; 1.00MM
12	Rod Bearing Half Upper/Lower	03	FP-3939859	Upper/Lower for machine split rods; STD
12	Rod Bearing Half Upper/Lower	02-98	FP-3901171	.25MM
12	Rod Bearing Half Upper/Lower	02-98	FP-3901172	.50MM
12	Rod Bearing Half Upper/Lower	02-98	FP-3901173	.75MM
12	Rod Bearing Half Upper/Lower	02-98	FP-3901174	1.00MM
12	Rod Bearing Half Upper/Lower	02-98	FP-3939859	STD
1	Crankshaft	02-01	FP-3929037	With Gear
1	Main Set	04-98	FP-3802070	STD
1	Main Set	04-98	FP-3802071	.25MM
1	Main Set	04-98	FP-3802072	.50MM
1	Main Set	04-98	FP-3802073	.75MM
1	Main Set	04-98	FP-3802074	1.00MM
QTY	Engine Oil Seals	YEARS	PART NO.	DESCRIPTION
1	Oil Seal Kit	04-99	FP-3804899	Engine Timing Cover; Timing Cover Oil Seal; Includes Installation Tools
QTY	Expansion Plug	YEARS	PART NO.	DESCRIPTION
13	Expansion Plug	04	FP-3007635	1.00" Dia.
4	Expansion Plug	02-98	FP-3007635	Behind pushrod cover; 1.00" Dia.
14	Expansion Plug	02-98	FP-3007635	Cyl. Head; 1.00" Dia.
1	Expansion Plug	02-98	FP-3900687	Camshaft plug
QTY	Fuel	YEARS	PART NO.	DESCRIPTION
6	Fuel Injector Washer	04-02	FP-3937142	Fuel Injector
6	Copper Washer	01-99	FP-3906659	Fuel Injector
6	O-Ring	02-99	FP-3029820	Fuel Injector
1	Electric Fuel Pump	04	FP-4089602	Option FF9492
1	Electric Fuel Pump	02-98	FP-3990105	Fuel Transfer Pump
8	Oil Seal	04-00	FP-3963983	Fuel Drain Tube; M12
4	Oil Seal	04-00	FP-3963983	Fuel Supply Tube; M12
2	Oil Seal	04-00	FP-3963988	Fuel Drain Tube; M14
1	Cover Plate Gasket	04-98	FP-3939258	Fuel Pump
2	Washer	99-98	FP-3918191	Fuel Drain Tube; .500" I.D., Banjo Connector
8	Washer	99-98	FP-3918191	Fuel Supply Tube; .500" I.D., Banjo Connector
2	Washer	99-98	FP-3918191	Fuel Supply Tube; Loc. Fuel Pump; .500" I.D., Banjo Connector
2	Washer	99-98	FP-3918192	Fuel Drain Tube
QTY	Gaskets	YEARS	PART NO.	DESCRIPTION
1	Oil Cooler Core Inner Gasket	02-98	FP-3926760	

(continued on next page)

5.9L OHV Turbo - Intercooled L6 (24 Valve), 102mm Bore (Cummins Eng.), MFI Diesel Turbo - Intercooled 5
"VIN 7" "Eng. Code 6BTA5.9" 2004-1998 (cont.)

QTY	Gaskets (cont.)	YEARS	PART NO.	DESCRIPTION
2	Air Intake Gasket	04-98	FP-3969988	
1	Hydraulic Pump Gasket	01-98	FP-3008400	Hydraulic pump mounting
1	Gear Housing Gasket	02-98	FP-3938156	Timing gear cover to block
1	Push Rod Cover Gasket	02-98	FP-3284623	
1	O-Ring	04	FP-3678925	Cylinder Block; M10 x 1.00; For use with 3678924 Threaded Plug; M10 x 1.00
1	O-Ring	04-03	FP-3678786	Cylinder Block; For use with 3678791 Threaded Plug
1	O-Ring	04-03	FP-3678912	Cylinder Block
1	O-Ring	04-03	FP-3679139	Cylinder Block; For use with 3089567 Threaded Plug
1	O-Ring	03	FP-3678925	Cylinder Block; For use with 3678924 Threaded Plug; M10 x 1.00
2	O-Ring	02-01	FP-3678925	Cylinder Block; For use with 3678924 Threaded Plug; M10 x 1.00
1	O-Ring	02-98	FP-3926047	Cylinder Block; Camshaft rear plug seal
2	O-Ring	99-98	FP-3678925	Cylinder Block; For use with 3678924 Threaded Plug; M10 x 1.00
1	Gasket Conversion Set	04-03	FP-4089173 *	Lower set
1	Gasket Conversion Set	02-00	FP-3800833 *	
1	Gasket Conversion Set	99-98	FP-3800487 *	
1	Head Gasket	04-03	FP-3958644 *	A Grade; 1.18mm Thick
1	Head Gasket	04-03	FP-3958645 *	B Grade; 1.25mm Thick
1	Head Gasket	02-98	FP-3977063	.061" Thickness
1	Head Set	04-03	FP-4089819 *	Upper set
1	Head Set	02-00	FP-4090037 *	.061" Thickness Head Gasket
1	Head Set	99-98	FP-4090035	.061" Thickness Head Gasket
26	Head Bolt	04-98	FP-3927063	M12 x 1.75 x 131MM Length
6	Grommet	02-98	FP-3928759	Push Rod Cover
1	O-Ring	04	FP-3010937	Fuel Transfer Pump
1	O-Ring	03	FP-3916284	Fuel Transfer Pump; Use with pump no. 3957784
1	O-Ring	04-03	FP-3949688	Fuel Pump Mounting; Fuel Pump to Gear Cover
1	O-Ring	00	FP-3935032	Fuel Pump Mounting
1	O-Ring	98	FP-3910503	Fuel Pump Mounting
6	O-Ring	02-99	FP-3029820	Fuel Injection
6	O-Ring	02-98	FP-3867043	Fuel Injection; Fuel Injector Supply Tube
1	Oil Filter Head Gasket	02-98	FP-3942915	
1	Oil Suction Tube Gasket	04-03	FP-3949562	
1	Oil Pan Gasket	04-03	FP-3958165	
1	Oil Pan Gasket	02-98	FP-3959052	
1	Pick-Up Tube Gasket	02-98	FP-3938157	
1	Rect. or Square Seal	02-99	FP-3903475	Crankcase Breather
1	O-Ring	04-00	FP-3946188	Oil Dipstick Tube
1	O-Ring	04-98	FP-3929457	Oil Filter Head; Threaded Plug
6	Exhaust Manifold Gasket	04-98	FP-3946275	
1	Intake Manifold Gasket	02	FP-3938152	Manifold Cover
1	Int. Manif. Cover Plate Gskt.	01-98	FP-3914029	
1	O-Ring	04	FP-3957440	Valve Cover
1	O-Ring	04-03	FP-3073966	Valve Cover; Crankcase Breather
1	O-Ring	03	FP-3957440	Position Sensor
1	O-Ring	02-98	FP-3678912	Temperature Sensor; Air Temperature
1	O-Ring	02-98	FP-3678912	Temperature Sensor; Water Temperature
1	O-Ring	02-98	FP-3910260 *	Flywheel Housing Plug
1	Oil Seal Kit	04	FP-4089342	Engine Crankshaft; Loc. Rear; Includes Installation Tools
1	Oil Seal Kit	04-98	FP-3802820	Engine Crankshaft; Loc. Front; Incl. wear sleeve
1	Oil Seal Kit	04-98	FP-3926126	Engine Crankshaft; Loc. Rear
1	Rear Cover Gasket	02-98	FP-3928493	0.8mm Thick
1	Rect. or Square Seal	02-98	FP-3942454	Thermostat
1	Oil Seal	03-98	FP-3937111	Engine Timing Cover; Timing Cover Oil Seal
1	Turbocharger Mounting Gasket	00-98	FP-3901356	
1	Turbocharger Gasket	02-01	FP-3709861	Mounting; Holset part number equivalent
2	O-Ring	04-98	FP-3922794	Turbocharger; Flexible Hose
1	O-Ring	04-98	FP-3931824	Turbocharger; Loc. Oil Drain Tube
1	O-Ring	02-98	FP-3883284	Air Transfer Pipe; For 3.00" Dia. Turbocharger elbow
1	Valve Cover Gasket	02-98	FP-3935878	
QTY	Lifters	YEARS	PART NO.	DESCRIPTION
24	Lifter	04-03	FP-3947759 *	Loc. Intake & Exhaust
24	Lifter	02-98	FP-3942565	Loc. Intake & Exhaust
QTY	Lubrication System & Oil Pumps	YEARS	PART NO.	DESCRIPTION
1	Oil Pump	02-98	FP-4939587	
1	Oil Pressure Regulator	02-98	FP-3918428	Oil Press. Regulator Plunger
QTY	Piston Rings	YEARS	PART NO.	DESCRIPTION
6	Ring Set Single Cylinder	04-03	FP-4089181	.50mm Oversize
6	Ring Set Single Cylinder	04-03	FP-4089182	1.00mm Oversize

(continued on next page)

* New Item — Check For Availability

Dodge Truck

5 5.9L OHV Turbo - Intercooled L6 (24 Valve), 102mm Bore (Cummins Eng.), MFI Diesel Turbo - Intercooled (cont.) "VIN 7" "Eng. Code 6BTA5.9" 2004-1998

QTY	Piston Rings (cont.)	YEARS	PART NO.	DESCRIPTION
6	Ring Set Single Cylinder	04-03	FP-4089258	STD
6	Ring Set Single Cylinder	02-98	FP-3804990	STD
6	Ring Set Single Cylinder	02-98	FP-3806201	.50mm Oversize
6	Ring Set Single Cylinder	02-98	FP-3806203	1.00mm Oversize
QTY	Pistons	YEARS	PART NO.	DESCRIPTION
6	Piston Body w/o Pin	04-03	FP-3949843	235 HP Calif. w/Catalytic Conv.; All 250 HP Eng.; .50mm Oversize
6	Piston Body w/o Pin	04-03	FP-3949844	235 HP Calif. w/Catalytic Conv.; All 250 HP Eng.; 1.00mm Oversize
6	Piston Body w/o Pin	04-03	FP-3958675	235 HP Calif. w/Catalytic Conv.; All 250 HP Eng.; STD
6	Piston Body w/o Pin	04-03	FP-3965497	305 HP; STD
6	Piston Body w/o Pin	04-03	FP-3966675	305 HP; .50mm Oversize
6	Piston Body w/o Pin	04-03	FP-3966676	305 HP; 1.00mm Oversize
6	Piston Body w/o Pin	02-01	FP-3946050 *	STD; A Grade
6	Piston Body w/o Pin	02-01	FP-3946051 *	STD; B Grade
6	Piston Body w/o Pin	02-01	FP-3946052 *	STD; C Grade
6	Piston Body w/o Pin	02-01	FP-3946053 *	.50mm Oversize
6	Piston Body w/o Pin	02-01	FP-3946054 *	1.00mm Oversize
6	Piston Body w/o Pin	00	FP-3946050 *	235 HP; STD; A Grade
6	Piston Body w/o Pin	00	FP-3946051 *	235 HP; STD; B Grade
6	Piston Body w/o Pin	00	FP-3946052 *	235 HP; STD; C Grade
6	Piston Body w/o Pin	00	FP-3946053 *	235 HP; .50mm Oversize
6	Piston Body w/o Pin	00	FP-3946054 *	235 HP; 1.00mm Oversize
6	Piston Body w/o Pin	00	FP-3946153	215 HP; STD; A Grade
6	Piston Body w/o Pin	00	FP-3946154	215 HP; STD; B Grade
6	Piston Body w/o Pin	00	FP-3946155	215 HP; STD; C Grade
6	Piston Body w/o Pin	00	FP-3946156	215 HP; .50mm Oversize
6	Piston Body w/o Pin	00	FP-3946157	215 HP; 1.00mm Oversize
6	Piston Body w/o Pin	99-98	FP-3946153	STD; A Grade
6	Piston Body w/o Pin	99-98	FP-3946154	STD; B Grade
6	Piston Body w/o Pin	99-98	FP-3946155	STD; C Grade
6	Piston Body w/o Pin	99-98	FP-3946156	.50mm Oversize
6	Piston Body w/o Pin	99-98	FP-3946157	1.00mm Oversize
6	Piston w/Retainer & Rings	04-03	FP-4089183	305 HP; .50mm Oversize
6	Piston w/Retainer & Rings	04-03	FP-4089184	305 HP; 1.00mm Oversize
6	Piston w/Retainer & Rings	04-03	FP-4089185	235 HP Calif. w/Catalytic Conv.; All 250 HP Eng.; .50mm Oversize
6	Piston w/Retainer & Rings	04-03	FP-4089186	235 HP Calif. w/Catalytic Conv.; All 250 HP Eng.; 1.00mm Oversize
6	Piston w/Retainer & Rings	04-03	FP-4089259	305 HP; STD
6	Piston w/Retainer & Rings	04-03	FP-4089260	235 HP Calif. w/Catalytic Conv.; All 250 HP Eng.; STD
6	Piston w/Pin, Retainer, Rings	04-03	FP-PK9183	305 HP; .50mm Oversize
6	Piston w/Pin, Retainer, Rings	04-03	FP-PK9184	305 HP; 1.00mm Oversize
6	Piston w/Pin, Retainer, Rings	04-03	FP-PK9185	235 HP Calif. w/Catalytic Conv.; All 250 HP Eng.; .50mm Oversize
6	Piston w/Pin, Retainer, Rings	04-03	FP-PK9186	235 HP Calif. w/Catalytic Conv.; All 250 HP Eng.; 1.00mm Oversize
6	Piston w/Pin, Retainer, Rings	04-03	FP-PK9259	305 HP; STD
6	Piston w/Pin, Retainer, Rings	04-03	FP-PK9260	235 HP Calif. w/Catalytic Conv.; All 250 HP Eng.; STD
6	Piston w/Retainer & Rings	02	FP-3800838	CPL 2907, 8034; STD; A Grade
6	Piston w/Retainer & Rings	02	FP-3800839	CPL 2907, 8034; STD; B Grade
6	Piston w/Retainer & Rings	02	FP-3800840	CPL 2907, 8034; STD; C Grade
6	Piston w/Retainer & Rings	02	FP-3800841	CPL 2907, 8034; .50mm Oversize
6	Piston w/Retainer & Rings	02	FP-3800842	CPL 2907, 8034; 1.00mm Oversize
6	Piston w/Pin, Retainer, Rings	02-01	FP-PK0838	STD; A Grade
6	Piston w/Pin, Retainer, Rings	02-01	FP-PK0839	STD; B Grade
6	Piston w/Pin, Retainer, Rings	02-01	FP-PK0840	STD; C Grade
6	Piston w/Pin, Retainer, Rings	02-01	FP-PK0841	.50mm Oversize
6	Piston w/Pin, Retainer, Rings	02-01	FP-PK0842	1.00mm Oversize
6	Piston w/Retainer & Rings	01	FP-3800838	STD; A Grade
6	Piston w/Retainer & Rings	01	FP-3800839	STD; B Grade
6	Piston w/Retainer & Rings	01	FP-3800840	STD; C Grade
6	Piston w/Retainer & Rings	01	FP-3800841	.50mm Oversize
6	Piston w/Retainer & Rings	01	FP-3800842	1.00mm Oversize
6	Piston w/Retainer & Rings	00	FP-3800781	215 HP; STD; A Grade
6	Piston w/Retainer & Rings	00	FP-3800782	215 HP; STD; B Grade
6	Piston w/Retainer & Rings	00	FP-3800783	215 HP; STD; C Grade
6	Piston w/Retainer & Rings	00	FP-3800784	215 HP; .50mm Oversize
6	Piston w/Retainer & Rings	00	FP-3800785	215 HP; 1.00mm Oversize
6	Piston w/Retainer & Rings	00	FP-3800838	235 HP; STD; A Grade
6	Piston w/Retainer & Rings	00	FP-3800839	235 HP; STD; B Grade
6	Piston w/Retainer & Rings	00	FP-3800840	235 HP; STD; C Grade
6	Piston w/Retainer & Rings	00	FP-3800841	235 HP; .50mm Oversize
6	Piston w/Retainer & Rings	00	FP-3800842	235 HP; 1.00mm Oversize
6	Piston w/Pin, Retainer, Rings	00	FP-PK0781	215 HP; STD; A Grade
6	Piston w/Pin, Retainer, Rings	00	FP-PK0782	215 HP; STD; B Grade
6	Piston w/Pin, Retainer, Rings	00	FP-PK0783	215 HP; STD; C Grade

(continued on next page)

5.9L OHV Turbo - Intercooled L6 (24 Valve), 102mm Bore (Cummins Eng.), MFI Diesel Turbo - Intercooled 5
"VIN 7" "Eng. Code 6BTA5.9" 2004-1998 (cont.)

QTY	Pistons (cont.)	YEARS	PART NO.	DESCRIPTION
6	Piston w/Pin, Retainer, Rings	00	FP-PK0784	215 HP; .50mm Oversize
6	Piston w/Pin, Retainer, Rings	00	FP-PK0785	215 HP; 1.00mm Oversize
6	Piston w/Pin, Retainer, Rings	00	FP-PK0838	235 HP; STD; A Grade
6	Piston w/Pin, Retainer, Rings	00	FP-PK0839	235 HP; STD; B Grade
6	Piston w/Pin, Retainer, Rings	00	FP-PK0840	235 HP; STD; C Grade
6	Piston w/Pin, Retainer, Rings	00	FP-PK0841	235 HP; .50mm Oversize
6	Piston w/Pin, Retainer, Rings	00	FP-PK0842	235 HP; 1.00mm Oversize
6	Piston w/Retainer & Rings	99-98	FP-3800781	STD; A Grade
6	Piston w/Retainer & Rings	99-98	FP-3800782	STD; B Grade
6	Piston w/Retainer & Rings	99-98	FP-3800783	STD; C Grade
6	Piston w/Retainer & Rings	99-98	FP-3800784	.50mm Oversize
6	Piston w/Retainer & Rings	99-98	FP-3800785	1.00mm Oversize
6	Piston w/Pin, Retainer, Rings	99-98	FP-PK0781	STD; A Grade
6	Piston w/Pin, Retainer, Rings	99-98	FP-PK0782	STD; B Grade
6	Piston w/Pin, Retainer, Rings	99-98	FP-PK0783	STD; C Grade
6	Piston w/Pin, Retainer, Rings	99-98	FP-PK0784	.50mm Oversize
6	Piston w/Pin, Retainer, Rings	99-98	FP-PK0785	1.00mm Oversize
6	Piston Cooling Nozzle	04	FP-3937214	For Fracture Split Rods
6	Piston Cooling Nozzle	03	FP-3937214	235 HP; 250 HP
6	Piston Cooling Nozzle	02-98	FP-3937214	
6	Pin	04-98	FP-3934047	
6	Pin Bushing	04-98	FP-4891178	
12	Piston Pin Retainer	04-98	FP-3920691	

QTY	Rocker Arm Parts	YEARS	PART NO.	DESCRIPTION
24	Adj. Screw Nut	04-02	FP-3927692	Rocker Lever Nut; 3/8" - 24 UNF
24	Adj. Screw Nut	01-98	FP-203131	Rocker Lever Nut; 3/8" - 24 UNF

QTY	Sleeves	YEARS	PART NO.	DESCRIPTION
6	Liner w/o Sealing Ring	04-98	FP-3904166	Standard Bore; To return block to Standard

QTY	Timing Components	YEARS	PART NO.	DESCRIPTION
1	Crank Gear	02-98	FP-3929027	

QTY	Turbocharger & Connections	YEARS	PART NO.	DESCRIPTION
4	Turbo Stud	04-98	FP-3818823	Turbocharger mounting studs; M10 x 1.50 x 42MM
1	Oil Drain Gasket	02-01	FP-3937706	Turbocharger oil drain gasket
1	Turbocharger Oil Drain Gasket	00	FP-3914388	Turbocharger
1	Drain Gasket	00-98	FP-3942725	Turbocharger; Turbocharger oil drain gasket

QTY	Valve Train Parts	YEARS	PART NO.	DESCRIPTION
48	Keeper	04-98	FP-3940123	Loc. Intake & Exhaust
5	Isolator, Rocker Cover Bolt	02-00	FP-3946168 *	
5	Isolator, Rocker Cover Bolt	99-98	FP-3942659	
24	Spring Cap	04-98	FP-3943198	
24	Spring	04-98	FP-4936080	Loc. Intake & Exhaust
12	Valve Stem Seal	04-03	FP-3955393	Loc. Intake
12	Valve Stem Seal	04-03	FP-3955394	Loc. Exhaust
12	Valve Stem Seal	02-98	FP-3942989	Loc. Intake; Color Yellow
12	Valve Stem Seal	02-98	FP-3945438	Loc. Exhaust; Color Green
12	Exhaust	04-98	FP-3940734	Chrome plated stem; 1.299" Head Dia., 0.2756" Stem Dia., 4.893" O.A.L.
12	Intake Valve Kit	04-98	FP-3802924	Incl. valve & keeper; 1.2990" Head Dia., .2756" Stem Dia., 4.9070" O.A.L.
12	Exhaust Valve Kit	04-98	FP-3802967	Incl. valve & keeper; 1.2990" Head Dia., .2756" Stem Dia., 4.8930" O.A.L.
12	Intake	04-98	FP-3940735	Chrome plated stem; 1.299" Head Dia., 0.2756" Stem Dia., 4.907" O.A.L.

QTY	Water Pumps & Thermostats	YEARS	PART NO.	DESCRIPTION
1	Water Pump - Heavy Duty	02-98	FP-3286278	
1	Water Pump Seal Ring	04-98	FP-3906697	Loc. Water Inlet; Rectangular Ring; Water Inlet; Rectangular Ring
1	Water Pump Seal Ring	04-98	FP-3906698	Water pump mounting; Rectangular Ring
1	Ball Brg.	04-98	FP-3910739	Fan Pulley

5.9L OHV Turbo - Intercooled L6 H.O. (24 Valve), 102mm Bore (Cummins Eng.), MFI Diesel Turbo - Intercooled "VIN C" "Eng. Code 6BTA5.9" 2008-2002 6

QTY	Connecting Rods	YEARS	PART NO.	DESCRIPTION
12	Con. Rod Bolt	03-02	FP-3900919 *	For machine split rods

QTY	Coolers	YEARS	PART NO.	DESCRIPTION
1	Oil Cooler	02	FP-3957544	

(continued on next page)

Dodge Truck

6 5.9L OHV Turbo - Intercooled L6 H.O. (24 Valve), 102mm Bore (Cummins Eng.), MFI Diesel Turbo - (cont.) Intercooled "VIN C" "Eng. Code 6BTA5.9" 2008-2002

QTY	Engine Bearings	YEARS	PART NO.	DESCRIPTION
1	Cam Brg.	08-02	FP-3903242 *	Loc. Intermediate; Oversize
1	Cam Brg.	08-02	FP-3904369 *	Loc. Front; Oversize
1	Cam Brg.	08-02	FP-3940059	
6	Rod Bearing Half Lower	07-03	FP-4892795	Lower for fracture split rods; .25MM
6	Rod Bearing Half Lower	07-03	FP-4892796	Lower for fracture split rods; .50MM
6	Rod Bearing Half Lower	07-03	FP-4892797	Lower for fracture split rods; .75MM
6	Rod Bearing Half Lower	07-03	FP-4892798	Lower for fracture split rods; 1.00MM
6	Rod Bearing Half Lower	07-03	FP-4893693	Lower for fracture split rods; STD
6	Rod Bearing Half Upper	07	FP-3969562 *	Upper for fracture split rods; STD
6	Rod Bearing Half Upper	07	FP-4932375 *	Upper for fracture split rods; .25MM
6	Rod Bearing Half Upper	07	FP-4932376 *	Upper for fracture split rods; .50MM
6	Rod Bearing Half Upper	07	FP-4932377 *	Upper for fracture split rods; .75MM
6	Rod Bearing Half Upper	07	FP-4932378 *	Upper for fracture split rods; 1.00MM
6	Rod Bearing Half Upper/Lower	06-03	FP-3901171	Upper for fracture split rods; .25MM
6	Rod Bearing Half Upper/Lower	06-03	FP-3901172	Upper for fracture split rods; .50MM
6	Rod Bearing Half Upper/Lower	06-03	FP-3901173	Upper for fracture split rods; .75MM
6	Rod Bearing Half Upper/Lower	06-03	FP-3901174	Upper for fracture split rods; 1.00MM
6	Rod Bearing Half Upper/Lower	06-03	FP-3939859	Upper for fracture split rods; STD
12	Rod Bearing Half Upper/Lower	03	FP-3901171	Upper/Lower for machine split rods; .25MM
12	Rod Bearing Half Upper/Lower	03	FP-3901172	Upper/Lower for machine split rods; .50MM
12	Rod Bearing Half Upper/Lower	03	FP-3901173	Upper/Lower for machine split rods; .75MM
12	Rod Bearing Half Upper/Lower	03	FP-3901174	Upper/Lower for machine split rods; 1.00MM
12	Rod Bearing Half Upper/Lower	03	FP-3939859	Upper/Lower for machine split rods; STD
12	Rod Bearing Half Upper/Lower	02	FP-3901171	.25MM
12	Rod Bearing Half Upper/Lower	02	FP-3901172	.50MM
12	Rod Bearing Half Upper/Lower	02	FP-3901173	.75MM
12	Rod Bearing Half Upper/Lower	02	FP-3901174	1.00MM
12	Rod Bearing Half Upper/Lower	02	FP-3939859	STD
6	Rod Pair	06-03	FP-3967060	Upper/Lower for fracture split rods; STD
6	Rod Pair	06-03	FP-3967061	Upper/Lower for fracture split rods; .25MM
6	Rod Pair	06-03	FP-3967062	Upper/Lower for fracture split rods; .50MM
6	Rod Pair	06-03	FP-3967063	Upper/Lower for fracture split rods; .75MM
6	Rod Pair	06-03	FP-3967064	Upper/Lower for fracture split rods; 1.00MM
1	Crankshaft	02	FP-3929037	Option BB9785; With Gear
1	Main Set	06-05	FP-3357480	STD
1	Main Set	06-02	FP-3802071	.25MM
1	Main Set	06-02	FP-3802072	.50MM
1	Main Set	06-02	FP-3802073	.75MM
1	Main Set	06-02	FP-3802074	1.00MM
1	Main Set	04-02	FP-3802070	STD
QTY	Engine Oil Seals	YEARS	PART NO.	DESCRIPTION
1	Oil Seal Kit	07-04	FP-3804899	Engine Timing Cover; Timing Cover Oil Seal; Includes Installation Tools & Debris shield
1	Oil Seal Kit	03	FP-3804899	Engine Timing Cover; Timing Cover Oil Seal; Option GG901ZW; Includes Installation Tools & Debris shield
QTY	Expansion Plug	YEARS	PART NO.	DESCRIPTION
13	Expansion Plug	07-03	FP-3007635	Cyl. Head; 1.00" Dia.
4	Expansion Plug	02	FP-3007635	Behind pushrod cover; 1.00" Dia.
14	Expansion Plug	02	FP-3007635	Cyl. Head; 1.00" Dia.
1	Expansion Plug	02	FP-3900687	Camshaft plug
QTY	Fuel	YEARS	PART NO.	DESCRIPTION
6	Fuel Injector Washer	07-02	FP-3937142	Fuel Injector to Head
1	Electric Fuel Pump	04	FP-4089602	Fuel Transfer Pump
1	Electric Fuel Pump	02	FP-3990105	Fuel Transfer Pump
2	Oil Seal	07	FP-3963983	Fuel Supply Tube; Option FF9959; M12
1	Cover Plate Gasket	07-02	FP-3939258	Fuel Pump
2	Oil Seal	07-02	FP-3963988	Fuel Drain Tube; M14
2	Oil Seal	06	FP-3963983	Fuel Supply Tube; Option FF9492; M12
4	Oil Seal	06	FP-3963983	Fuel Supply Tube; Option FF9849; M12
4	Oil Seal	05-04	FP-3963983	Fuel Supply Tube; M12
8	Oil Seal	05-02	FP-3963983	Fuel Drain Tube; M12
QTY	Gaskets	YEARS	PART NO.	DESCRIPTION
1	Oil Cooler Core Inner Gasket	02	FP-3926760	
2	Air Intake Gasket	07-02	FP-3969988	
1	Gear Housing Gasket	02	FP-3938156	Timing gear cover to block
1	Push Rod Cover Gasket	02	FP-3284623	
1	Accessory Drive Gasket	02	FP-3938655 *	Vacuum pump mounting gasket
1	O-Ring	07	FP-3679139	Cylinder Block; For use with 3089568 Threaded Plug
1	O-Ring	07-04	FP-3678786	Cylinder Block; For use with 3678791 Threaded Plug
1	O-Ring	07-04	FP-3678925	Cylinder Block; For use with 3678924 Threaded Plug; M10 x 1.00

(continued on next page)

* New Item — Check For Availability

5.9L OHV Turbo - Intercooled L6 H.O. (24 Valve), 102mm Bore (Cummins Eng.), MFI Diesel Turbo - 6 Intercooled "VIN C" "Eng. Code 6BTA5.9" 2008-2002 (cont.)

QTY	Gaskets (cont.)	YEARS	PART NO.	DESCRIPTION
1	O-Ring	06-05	FP-3678912	Cylinder Block; For use with 3680419 Threaded Plug
1	O-Ring	05	FP-3679139	Cylinder Block; For use with 3089568 Threaded Plug
1	O-Ring	04-03	FP-3678912	Cylinder Block
1	O-Ring	04-03	FP-3679139	Cylinder Block; For use with 3089567 Threaded Plug
1	O-Ring	03	FP-3678786	Cylinder Block; For use with 36778791 Threaded Plug
1	O-Ring	03	FP-3678925	Cylinder Block; M10 x 1.00
2	O-Ring	02	FP-3678925	Cylinder Block; M10 x 1.00
1	O-Ring	02	FP-3926047	Cylinder Block; Camshaft rear plug seal
1	Gasket Conversion Set	07-03	FP-4089173 *	Lower set
1	Gasket Conversion Set	02	FP-3800833 *	
1	Head Gasket	07-03	FP-3958644 *	A Grade; 1.18mm Thick
1	Head Gasket	07-03	FP-3958645 *	B Grade; 1.25mm Thick
1	Head Gasket	02	FP-3977063	.061" Thickness
1	Head Set	07-03	FP-4089819 *	Upper set
1	Head Set	02	FP-4090037 *	.061" Thickness Head Gasket
26	Head Bolt	07-02	FP-3927063	M12 x 1.75 x 131MM Length
6	Grommet	02	FP-3928759	Push Rod Cover
1	O-Ring	04	FP-3010937	Fuel Transfer Pump
1	O-Ring	03	FP-3916284	Fuel Transfer Pump; Use with pump no. 3957784
1	O-Ring	07-03	FP-3949688	Fuel Pump Mounting
6	O-Ring	02	FP-3029820	Fuel Injection
6	O-Ring	02	FP-3867043	Fuel Injection; Fuel Injector Supply Tube
1	Oil Filter Head Gasket	02	FP-3942915	
1	Oil Suction Tube Gasket	07-03	FP-3949562	
1	Oil Pan Gasket	07-03	FP-3958165	
1	Oil Pan Gasket	02	FP-3959052	
1	Pick-Up Tube Gasket	02	FP-3938157	
1	Rect. or Square Seal	02	FP-3903475	Crankcase Breather
2	O-Ring	07-04	FP-3946188	Oil Dipstick
2	O-Ring	07-02	FP-3946188	Oil Dipstick Tube
1	O-Ring	06	FP-3040817	Oil Drain Tube; Loc. Valve Cover
1	O-Ring	02	FP-3946188	Oil Drain Tube
1	O-Ring	07-05	FP-3929457	Oil Filter Head; For use with 3946947 Threaded plug
1	O-Ring	04-02	FP-3929457	Oil Filter Head; Threaded Plug
6	Exhaust Manifold Gasket	04-02	FP-3946275	
1	Intake Manifold Gasket	02	FP-3938152	Manifold Cover
1	O-Ring	06	FP-3035228	Breather Tube; Loc. Valve Cover
1	O-Ring	07	FP-3957440	Temperature/Pressure Sensor; Loc. Intake Manifold; For use with 4062313 Sensor
1	O-Ring	06-04	FP-3957440	Temperature/Pressure Sensor; Loc. Intake Manifold
1	O-Ring	05-03	FP-3073966	Valve Cover; Crankcase Breather
1	O-Ring	03	FP-3957440	Position Sensor
1	O-Ring	02	FP-3678912	Temperature Sensor; Air Temperature
1	O-Ring	02	FP-3678912	Temperature Sensor; Water Temperature
1	O-Ring	02	FP-3910260 *	Flywheel Housing Plug
1	Oil Seal Kit	07-04	FP-4089342	Engine Crankshaft; Includes Installation Tools
1	Oil Seal Kit	06-02	FP-3802820	Engine Crankshaft; Loc. Front; Incl. wear sleeve
1	Oil Seal Kit	06-02	FP-3926126	Engine Crankshaft; Loc. Rear
1	Rear Cover Gasket	02	FP-3928493	0.8mm Thick
1	Rect. or Square Seal	02	FP-3942454	Thermostat
1	Oil Seal	07-06	FP-3937111	Engine Timing Cover; Timing Cover Oil Seal
1	Oil Seal	03-02	FP-3937111	Engine Timing Cover; Timing Cover Oil Seal
1	Turbocharger Gasket	02	FP-3709861	Mounting; Holset part number equivalent
1	O-Ring	07-02	FP-3922794	Turbocharger; Flexible Hose
1	O-Ring	04-02	FP-3931824	Turbocharger; Loc. Oil Drain Tube
1	O-Ring	02	FP-3883284	Air Transfer Pipe; For 3.00" Dia. Turbocharger elbow
1	Valve Cover Gasket	02	FP-3935878	
QTY	Lifters	YEARS	PART NO.	DESCRIPTION
24	Lifter	07-03	FP-3947759 *	Loc. Intake & Exhaust
24	Lifter	02	FP-3942565	Loc. Intake & Exhaust
QTY	Lubrication System & Oil Pumps	YEARS	PART NO.	DESCRIPTION
1	Oil Pump	02	FP-4939587	
1	Oil Pressure Regulator	02	FP-3918428	Oil Press. Regulator Plunger
QTY	Piston Rings	YEARS	PART NO.	DESCRIPTION
6	Ring Set Single Cylinder	08-03	FP-4089181	.50mm Oversize
6	Ring Set Single Cylinder	08-03	FP-4089182	1.00mm Oversize
6	Ring Set Single Cylinder	08-03	FP-4089258	STD
6	Ring Set Single Cylinder	02	FP-3804990	STD
6	Ring Set Single Cylinder	02	FP-3806201	.50mm Oversize

(continued on next page)

* New Item — Check For Availability

Dodge Truck

6 5.9L OHV Turbo - Intercooled L6 H.O. (24 Valve), 102mm Bore (Cummins Eng.), MFI Diesel Turbo - (cont.) Intercooled "VIN C" "Eng. Code 6BTA5.9" 2008-2002

QTY	Piston Rings (cont.)	YEARS	PART NO.	DESCRIPTION
6	Ring Set Single Cylinder	02	FP-3806203	1.00mm Oversize
QTY	Pistons	YEARS	PART NO.	DESCRIPTION
6	Piston Body w/o Pin	08-05	FP-3970126	.50mm Oversize
6	Piston Body w/o Pin	08-05	FP-3970127	1.00mm Oversize
6	Piston Body w/o Pin	08-05	FP-3970192	STD
6	Piston Body w/o Pin	04	FP-3970126	From 1/5/2004; .50mm Oversize
6	Piston Body w/o Pin	04	FP-3970127	From 1/5/2004; 1.00mm Oversize
6	Piston Body w/o Pin	04	FP-3970192	From 1/5/2004; STD
6	Piston Body w/o Pin	04-03	FP-3965497	305 HP; To 1/4/2004; STD
6	Piston Body w/o Pin	04-03	FP-3966675	305 HP; To 1/4/2004; .50mm Oversize
6	Piston Body w/o Pin	04-03	FP-3966676	305 HP; To 1/4/2004; 1.00mm Oversize
6	Piston Body w/o Pin	02	FP-3946050 *	STD; A Grade
6	Piston Body w/o Pin	02	FP-3946051 *	STD; B Grade
6	Piston Body w/o Pin	02	FP-3946052 *	STD; C Grade
6	Piston Body w/o Pin	02	FP-3946053 *	.50mm Oversize
6	Piston Body w/o Pin	02	FP-3946054 *	1.00mm Oversize
6	Piston w/Retainer & Rings	08-05	FP-4089669	STD
6	Piston w/Retainer & Rings	08-05	FP-4089670	.50mm Oversize
6	Piston w/Retainer & Rings	08-05	FP-4089671	1.00mm Oversize
6	Piston w/Pin, Retainer, Rings	08-05	FP-PK9669	STD
6	Piston w/Pin, Retainer, Rings	08-05	FP-PK9670	.50mm Oversize
6	Piston w/Pin, Retainer, Rings	08-05	FP-PK9671	1.00mm Oversize
6	Piston w/Retainer & Rings	04	FP-4089183	305 HP; To 1/4/2004; .50mm Oversize
6	Piston w/Retainer & Rings	04	FP-4089184	305 HP; To 1/4/2004; 1.00mm Oversize
6	Piston w/Retainer & Rings	04	FP-4089259	305 HP; To 1/4/2004; STD
6	Piston w/Retainer & Rings	04	FP-4089669	From 1/5/2004; STD
6	Piston w/Retainer & Rings	04	FP-4089670	From 1/5/2004; .50mm Oversize
6	Piston w/Retainer & Rings	04	FP-4089671	From 1/5/2004; 1.00mm Oversize
6	Piston w/Pin, Retainer, Rings	04	FP-PK9669	From 1/5/2004; STD
6	Piston w/Pin, Retainer, Rings	04	FP-PK9670	From 1/5/2004; .50mm Oversize
6	Piston w/Pin, Retainer, Rings	04	FP-PK9671	From 1/5/2004; 1.00mm Oversize
6	Piston w/Pin, Retainer, Rings	04-03	FP-PK9183	305 HP; To 1/4/2004; .50mm Oversize
6	Piston w/Pin, Retainer, Rings	04-03	FP-PK9184	305 HP; To 1/4/2004; 1.00mm Oversize
6	Piston w/Pin, Retainer, Rings	04-03	FP-PK9259	305 HP; To 1/4/2004; STD
6	Piston w/Retainer & Rings	03	FP-4089183	.50mm Oversize
6	Piston w/Retainer & Rings	03	FP-4089184	1.00mm Oversize
6	Piston w/Retainer & Rings	03	FP-4089259	STD
6	Piston w/Retainer & Rings	02	FP-3800838	CPL 2907, 8034; STD; A Grade
6	Piston w/Retainer & Rings	02	FP-3800839	CPL 2907, 8034; STD; B Grade
6	Piston w/Retainer & Rings	02	FP-3800840	CPL 2907, 8034; STD; C Grade
6	Piston w/Retainer & Rings	02	FP-3800841	CPL 2907, 8034; .50mm Oversize
6	Piston w/Retainer & Rings	02	FP-3800842	CPL 2907, 8034; 1.00mm Oversize
6	Piston w/Pin, Retainer, Rings	02	FP-PK0838	CPL 2907, 8034; STD; A Grade
6	Piston w/Pin, Retainer, Rings	02	FP-PK0839	CPL 2907, 8034; STD; B Grade
6	Piston w/Pin, Retainer, Rings	02	FP-PK0840	CPL 2907, 8034; STD; C Grade
6	Piston w/Pin, Retainer, Rings	02	FP-PK0841	CPL 2907, 8034; .50mm Oversize
6	Piston w/Pin, Retainer, Rings	02	FP-PK0842	CPL 2907, 8034; 1.00mm Oversize
6	Piston Cooling Nozzle	04-03	FP-3937214	Use w/FP-4089259 piston
6	Piston Cooling Nozzle	02	FP-3937214	
6	Pin	08-02	FP-3934047	
6	Pin Bushing	08-02	FP-4891178	
12	Piston Pin Retainer	08-02	FP-3920691	
QTY	Rocker Arm Parts	YEARS	PART NO.	DESCRIPTION
24	Adj. Screw Nut	07-02	FP-3927692	Rocker Lever Nut; 3/8" - 24 UNF
QTY	Sleeves	YEARS	PART NO.	DESCRIPTION
6	Liner w/o Sealing Ring	07-02	FP-3904166	Standard Bore; To return block to Standard
QTY	Timing Components	YEARS	PART NO.	DESCRIPTION
1	Crank Gear	02	FP-3929027	
QTY	Turbocharger & Connections	YEARS	PART NO.	DESCRIPTION
4	Turbo Stud	04-02	FP-3818823	M10 x 1.50; Turbocharger mounting studs; M10 x 1.50 x 42MM
1	Oil Drain Gasket	02	FP-3937706	Turbocharger oil drain gasket
QTY	Valve Train Parts	YEARS	PART NO.	DESCRIPTION
48	Keeper	07-02	FP-3940123	Loc. Intake & Exhaust
5	Isolator, Rocker Cover Bolt	02	FP-3946168 *	
24	Spring Cap	07-02	FP-3943198	
24	Spring	07-02	FP-4936080	Loc. Intake & Exhaust
12	Valve Stem Seal	07-03	FP-3955393	Loc. Intake
12	Valve Stem Seal	07-03	FP-3955394	Loc. Exhaust

(continued on next page)

**5.9L OHV Turbo - Intercooled L6 H.O. (24 Valve), 102mm Bore (Cummins Eng.), MFI Diesel Turbo - 6
Intercooled "VIN C" "Eng. Code 6BTA5.9" 2008-2002 (cont.)**

QTY	Valve Train Parts (cont.)	YEARS	PART NO.	DESCRIPTION
12	Valve Stem Seal	02	FP-3942989	Loc. Intake; Color Yellow
12	Valve Stem Seal	02	FP-3945438	Loc. Exhaust; Color Green
12	Exhaust	05-04	FP-3968183 *	
12	Exhaust	03-02	FP-3940734	Chrome plated stem; 1.299" Head Dia., 0.2756" Stem Dia., 4.893" O.A.L.
12	Intake Valve Kit	07-02	FP-3802924	Incl. valve & keeper; 1.2990" Head Dia., .2756" Stem Dia., 4.9070" O.A.L.
12	Intake	07-02	FP-3940735	Chrome plated stem; 1.299" Head Dia., 0.2756" Stem Dia., 4.907" O.A.L.
12	Exhaust Valve Kit	05-04	FP-4089672 *	Incl. valve, valve stem seal & keeper
12	Exhaust Valve Kit	03-02	FP-3802967	Incl. valve & keeper; 1.2990" Head Dia., .2756" Stem Dia., 4.8930" O.A.L.

QTY	Water Pumps & Thermostats	YEARS	PART NO.	DESCRIPTION
1	Water Pump - Heavy Duty	02	FP-3286278	
1	Water Pump Seal Ring	07-02	FP-3906697	Loc. Water Inlet; Rectangular Ring; Water Inlet; Rectangular Ring
1	Water Pump Seal Ring	07-02	FP-3906698	Water pump mounting; Rectangular Ring
1	Ball Brg.	07-02	FP-3910739	Fan Pulley

**6.7L OHV Turbo - Intercooled L6 H.O. (24 Valve), 107mm Bore (Cummins Eng.), MFI Diesel Turbo - 7
Intercooled "VIN A" "Eng. Code ISB6.7-305" 2009-2007**

QTY	Engine Bearings	YEARS	PART NO.	DESCRIPTION
1	Cam Brg.	07	FP-3940059	
6	Rod Bearing Half Lower	09-07	FP-4892795	.25mm Undersize; Lower for fracture split rods; .25MM
6	Rod Bearing Half Lower	09-07	FP-4892796	.50mm Undersize; Lower for fracture split rods; .50MM
6	Rod Bearing Half Lower	09-07	FP-4892797	.75mm Undersize; Lower for fracture split rods; .75MM
6	Rod Bearing Half Lower	09-07	FP-4892798	1.00mm Undersize; Lower for fracture split rods; 1.00MM
6	Rod Bearing Half Lower	09-07	FP-4893693	Standard; Lower for fracture split rods; STD
6	Rod Bearing Half Upper	09-07	FP-3969562 *	Standard; Upper for fracture split rods; STD
6	Rod Bearing Half Upper	09-07	FP-4932375 *	.25mm Undersize; Upper for fracture split rods; .25MM
6	Rod Bearing Half Upper	09-07	FP-4932376 *	.50mm Undersize; Upper for fracture split rods; .50MM
6	Rod Bearing Half Upper	09-07	FP-4932377 *	.75mm Undersize; Upper for fracture split rods; .75MM
6	Rod Bearing Half Upper	09-07	FP-4932378 *	1.00mm Undersize; Upper for fracture split rods; 1.00MM

QTY	Expansion Plug	YEARS	PART NO.	DESCRIPTION
3	Expansion Plug	07	FP-3007635	Behind pushrod cover; 1.00" Dia.

QTY	Fuel	YEARS	PART NO.	DESCRIPTION
1	Cover Plate Gasket	07	FP-3939258	Fuel Transfer Pump

QTY	Gaskets	YEARS	PART NO.	DESCRIPTION
1	O-Ring	07	FP-3678786	Cylinder Block; For use with 3678791 Threaded Plug
1	O-Ring	07	FP-3678925	Cylinder Block; For use with 3678924 Threaded Plug; M10 x 1.00
1	O-Ring	07	FP-3679139	Cylinder Block; For use with 3089568 Threaded Plug
1	O-Ring	07	FP-3946689 *	Access Hole Cover Seal
1	Gasket Conversion Set	09-07	FP-4955355 *	Lower set
1	Head Set	09-07	FP-4955354 *	Upper set
26	Head Bolt	07	FP-3927063	M12 x 1.75 x 131MM Length
1	Oil Suction Tube Gasket	07	FP-3949562	
1	Oil Pan Gasket	07	FP-3958165	
1	O-Ring	07	FP-3946188	Oil Dipstick Tube
1	O-Ring	07	FP-3929457	Oil Filter Head; For use with 3946947 Threaded plug
1	Oil Seal Kit	07	FP-3802820	Engine Crankshaft; Loc. Front; Incl. wear sleeve
1	Oil Seal Kit	07	FP-3926126	Engine Crankshaft; Loc. Rear
1	Oil Seal Kit	07	FP-4089342	Engine Crankshaft; Loc. Rear
1	O-Ring	07	FP-3946689 *	Access Hole Cover Seal
1	Oil Seal	07	FP-3937111	Engine Timing Cover; Timing Cover Oil Seal
1	O-Ring	07	FP-3678786	Turbocharger; Flexible Hose
1	O-Ring	07	FP-3922794	Turbocharger; Flexible Hose

QTY	Lifters	YEARS	PART NO.	DESCRIPTION
24	Lifter	07	FP-3947759 *	Loc. Intake & Exhaust

QTY	Piston Rings	YEARS	PART NO.	DESCRIPTION
6	Ring Set Single Cylinder	09-07	FP-4955366 *	STD

QTY	Pistons	YEARS	PART NO.	DESCRIPTION
6	Piston Kit w/Pin & Retainers	09-07	FP-4955365 *	STD
6	Piston Cooling Nozzle	09-07	FP-4937308 *	
6	Pin	09-07	FP-4931041 *	
6	Pin Bushing	09-07	FP-4891178	
12	Piston Pin Retainer	09-07	FP-3920691	

(continued on next page)

Dodge Truck

7 6.7L OHV Turbo - Intercooled L6 H.O. (24 Valve), 107mm Bore (Cummins Eng.), MFI Diesel Turbo - (cont.) Intercooled "VIN A" "Eng. Code ISB6.7-305" 2009-2007				
QTY	Rocker Arm Parts	YEARS	PART NO.	DESCRIPTION
24	Adj. Screw Nut	07	FP-3927692	Rocker Lever Nut; 3/8" - 24 UNF
QTY	Valve Train Parts	YEARS	PART NO.	DESCRIPTION
48	Keeper	07	FP-3940123	Loc. Intake & Exhaust
24	Spring Cap	07	FP-3943198	
24	Spring	07	FP-4936080	Loc. Intake & Exhaust
12	Valve Stem Seal	07	FP-3955393	Loc. Intake
12	Valve Stem Seal	07	FP-3955394	Loc. Exhaust
12	Intake Valve Kit	07	FP-3802924	Incl. valve & keeper; 1.2990" Head Dia., .2756" Stem Dia., 4.9070" O.A.L.
12	Intake	07	FP-3940735	Chrome plated stem; 1.299" Head Dia., 0.2756" Stem Dia., 4.907" O.A.L.
QTY	Water Pumps & Thermostats	YEARS	PART NO.	DESCRIPTION
1	Water Pump Seal Ring	07	FP-3906697	Loc. Water Inlet; Rectangular Ring; Water Inlet; Rectangular Ring
1	Water Pump Seal Ring	07	FP-3906698	Water pump mounting; Rectangular Ring
1	Ball Brg.	07	FP-3910739	Fan Pulley

Numerical List

Part No.	Manufacturer and Line No.	Part No.	Manufacturer and Line No.	Part No.	Manufacturer and Line No.
FP-203131	DT 2, 4, 5	FP-3900250	DT 1, 2, 3	FP-3922573WP	DT 2, 3
FP-3007635	DT 1, 2, 3, 4, 5, 6, 7	FP-3900267	DT 1, 2, 3	FP-3922574	DT 2, 3
FP-3008400	DT 1, 2, 3, 4, 5	FP-3900276	DT 1, 2	FP-3922574WP	DT 2, 3
FP-3010937	DT 4, 5, 6	FP-3900299	DT 1, 2, 3	FP-3922575	DT 2, 3
FP-3029820	DT 5, 6	FP-3900687	DT 1, 2, 3, 4, 5, 6	FP-3922575WP	DT 2, 3
FP-3035228	DT 6	FP-3900808	DT 1, 2	FP-3922794	DT 4, 5, 6, 7
FP-3040817	DT 6	FP-3900919*	DT 1, 2, 3, 4, 5, 6	FP-3923261	DT 2
FP-3073966	DT 4, 5, 6	FP-3901020	DT 1	FP-3923331	DT 1, 2
FP-3283337	DT 1, 2, 3	FP-3901085	DT 1, 2, 3	FP-3926047	DT 2, 3, 4, 5, 6
FP-3283339	DT 1, 2, 3	FP-3901171	DT 1, 2, 3, 4, 5, 6	FP-3926103	DT 2, 3
FP-3283570	DT 1, 2, 3	FP-3901172	DT 1, 2, 3, 4, 5, 6	FP-3926126	DT 4, 5, 6, 7
FP-3284377	DT 1, 2, 3	FP-3901173	DT 1, 2, 3, 4, 5, 6	FP-3926631	DT 2, 3
FP-3284623	DT 1, 2, 3, 4, 5, 6	FP-3901174	DT 1, 2, 3, 4, 5, 6	FP-3926631WP	DT 2, 3
FP-3286277	DT 1, 2, 3	FP-3901306	DT 1, 2, 3	FP-3926632	DT 2, 3
FP-3286278	DT 2, 4, 5, 6	FP-3901356	DT 1, 2, 3, 4, 5	FP-3926632WP	DT 2, 3
FP-3357480	DT 4, 6	FP-3902425	DT 2	FP-3926633	DT 2, 3
FP-3678786	DT 4, 5, 6, 7	FP-3903242*	DT 1, 2, 3, 4, 5, 6	FP-3926633WP	DT 2, 3
FP-3678912	DT 4, 5, 6	FP-3903380	DT 1, 2, 3	FP-3926634	DT 2, 3
FP-3678925	DT 4, 5, 6, 7	FP-3903475	DT 1, 2, 3, 4, 5, 6	FP-3926634WP	DT 2, 3
FP-3679139	DT 4, 5, 6, 7	FP-3903575	DT 1, 2	FP-3926635	DT 2, 3
FP-3709861	DT 4, 5, 6	FP-3903728	DT 1, 2	FP-3926635WP	DT 2, 3
FP-3800487	DT 4, 5	FP-3904105	DT 1, 2, 3	FP-3926760	DT 1, 2, 3, 4, 5, 6
FP-3800781	DT 4, 5	FP-3904166	DT 1, 2, 3, 4, 5, 6	FP-3927063	DT 4, 5, 6, 7
FP-3800782	DT 4, 5	FP-3904369*	DT 1, 2, 3, 4, 5, 6	FP-3927692	DT 2, 3, 4, 5, 6, 7
FP-3800783	DT 4, 5	FP-3904408	DT 1, 2, 3	FP-3928493	DT 1, 2, 3, 4, 5, 6
FP-3800784	DT 4, 5	FP-3904409	DT 1, 2, 3	FP-3928759	DT 4, 5, 6
FP-3800785	DT 4, 5	FP-3905443	DT 1, 2, 3	FP-3929027	DT 2, 3, 4, 5, 6
FP-3800833	DT 4, 5, 6	FP-3906080	DT 1, 2, 3	FP-3929037	DT 1, 2, 3, 4, 5, 6
FP-3800838	DT 4, 5, 6	FP-3906081	DT 1, 2, 3	FP-3929042	DT 1, 2
FP-3800839	DT 4, 5, 6	FP-3906206	DT 1, 2, 3	FP-3929457	DT 3, 4, 5, 6, 7
FP-3800840	DT 4, 5, 6	FP-3906659	DT 2, 3, 4, 5	FP-3929734*	DT 2, 3
FP-3800841	DT 4, 5, 6	FP-3906697	DT 1, 2, 3, 4, 5, 6, 7	FP-3929792	DT 1, 2, 3
FP-3800842	DT 4, 5, 6	FP-3906698	DT 1, 2, 3, 4, 5, 6, 7	FP-3930324	DT 3
FP-3802070	DT 1, 2, 3, 4, 5, 6	FP-3906854	DT 1, 2, 3	FP-3930906	DT 1, 2, 3
FP-3802071	DT 1, 2, 3, 4, 5, 6	FP-3907163	DT 1	FP-3931623	DT 1, 2, 3
FP-3802072	DT 1, 2, 3, 4, 5, 6	FP-3907163WP	DT 1	FP-3931824	DT 4, 5, 6
FP-3802073	DT 1, 2, 3, 4, 5, 6	FP-3907555	DT 1, 2	FP-3932453*	DT 2, 3
FP-3802074	DT 1, 2, 3, 4, 5, 6	FP-3908815	DT 1	FP-3934047	DT 2, 3, 4, 5, 6
FP-3802132	DT 1	FP-3908815WP	DT 1	FP-3934048	DT 1
FP-3802134	DT 1	FP-3908816	DT 1	FP-3935032	DT 4, 5
FP-3802160	DT 1	FP-3908816WP	DT 1	FP-3935449	DT 3
FP-3802230	DT 1, 2, 3	FP-3909356	DT 1, 2, 3	FP-3935878	DT 4, 5, 6
FP-3802232	DT 1, 2, 3	FP-3909397	DT 1, 2, 3	FP-3936876	DT 1, 2, 3
FP-3802234	DT 1, 2, 3	FP-3909410	DT 1, 2, 3, 4	FP-3937111	DT 1, 2, 3, 4, 5, 6, 7
FP-3802245	DT 1, 2, 3	FP-3910260*	DT 2, 3, 4, 5, 6	FP-3937142	DT 4, 5, 6
FP-3802245S	DT 1, 2, 3	FP-3910503	DT 4, 5	FP-3937214	DT 2, 3, 4, 5, 6
FP-3802248	DT 2	FP-3910739	DT 1, 2, 3, 4, 5, 6, 7	FP-3937438*	DT 1, 2, 3
FP-3802249	DT 2	FP-3910810	DT 1, 2, 3	FP-3937706	DT 4, 5, 6
FP-3802250	DT 2	FP-3910811	DT 1, 2, 3	FP-3938152	DT 4, 5, 6
FP-3802273	DT 2	FP-3910824	DT 1, 2, 3	FP-3938156	DT 1, 2, 3, 4, 5, 6
FP-3802355	DT 1, 2, 3	FP-3913994	DT 1, 2, 3	FP-3938157	DT 1, 2, 3, 4, 5, 6
FP-3802356	DT 1, 2, 3	FP-3914029	DT 1, 2, 3, 4, 5	FP-3938655*	DT 4, 6
FP-3802363	DT 1, 2, 3	FP-3914385	DT 1, 2	FP-3939258	DT 1, 2, 3, 4, 5, 6, 7
FP-3802363S	DT 1, 2, 3	FP-3914388	DT 1, 2, 3, 4, 5	FP-3939859	DT 1, 2, 3, 4, 5, 6
FP-3802364	DT 1, 2, 3	FP-3914389	DT 1, 2	FP-3940059	DT 4, 5, 6, 7
FP-3802364S	DT 1, 2, 3	FP-3915772	DT 2, 3	FP-3940123	DT 4, 5, 6, 7
FP-3802376	DT 1, 2, 3	FP-3916284	DT 4, 5, 6	FP-3940734	DT 4, 5, 6
FP-3802421	DT 2, 3	FP-3917324	DT 1, 2	FP-3940735	DT 4, 5, 6, 7
FP-3802422	DT 2, 3	FP-3918188	DT 2, 3	FP-3942454	DT 4, 5, 6
FP-3802423	DT 2, 3	FP-3918191	DT 1, 2, 3, 4, 5	FP-3942565	DT 4, 5, 6
FP-3802487	DT 2, 3	FP-3918192	DT 2, 3, 4, 5	FP-3942659	DT 4, 5
FP-3802489	DT 2, 3	FP-3918428	DT 2, 3, 4, 5, 6	FP-3942725	DT 4, 5
FP-3802490	DT 2, 3	FP-3918673	DT 2, 3	FP-3942915	DT 4, 5, 6
FP-3802493	DT 2, 3	FP-3919041	DT 2	FP-3942989	DT 4, 5, 6
FP-3802495	DT 2, 3	FP-3919041WP	DT 2	FP-3943198	DT 4, 5, 6, 7
FP-3802561	DT 2, 3	FP-3919044	DT 2	FP-3945438	DT 4, 5, 6
FP-3802562	DT 2, 3	FP-3919044WP	DT 2	FP-3946050*	DT 4, 5, 6
FP-3802563	DT 2, 3	FP-3919045	DT 2	FP-3946051*	DT 4, 5, 6
FP-3802564	DT 2, 3	FP-3919045WP	DT 2	FP-3946052*	DT 4, 5, 6
FP-3802565	DT 2, 3	FP-3920691	DT 1, 2, 3, 4, 5, 6, 7	FP-3946053*	DT 4, 5, 6
FP-3802712	DT 1	FP-3920773	DT 1, 2	FP-3946054*	DT 4, 5, 6
FP-3802820	DT 4, 5, 6, 7	FP-3920779	DT 1, 2, 3	FP-3946153	DT 4, 5
FP-3802924	DT 4, 5, 6, 7	FP-3920780	DT 1, 2, 3	FP-3946154	DT 4, 5
FP-3802967	DT 4, 5, 6	FP-3920781	DT 1, 2, 3	FP-3946155	DT 4, 5
FP-3804899	DT 4, 5, 6	FP-3920867	DT 2, 3	FP-3946156	DT 4, 5
FP-3804990	DT 4, 5, 6	FP-3920868	DT 2, 3	FP-3946157	DT 4, 5
FP-3806201	DT 4, 5, 6	FP-3921640	DT 1, 2, 3	FP-3946168*	DT 4, 5, 6
FP-3806203	DT 4, 5, 6	FP-3922488	DT 1, 2, 3	FP-3946188	DT 4, 5, 6, 7
FP-3818823	DT 1, 2, 3, 4, 5, 6	FP-3922571	DT 2, 3	FP-3946275	DT 4, 5, 6
FP-3867043	DT 4, 5, 6	FP-3922571WP	DT 2, 3	FP-3946689*	DT 4, 7
FP-3883284	DT 2, 3, 4, 5, 6	FP-3922572	DT 2, 3	FP-3947759	DT 4, 5, 6, 7
FP-3900242	DT 1, 2, 3	FP-3922572WP	DT 2, 3	FP-3949562	DT 4, 5, 6, 7
FP-3900245	DT 1, 2, 3	FP-3922573	DT 2, 3	FP-3949688	DT 4, 5, 6

Numerical List

Part No.	Manufacturer and Line No.	Part No.	Manufacturer and Line No.	Part No.	Manufacturer and Line No.
FP-3949843	DT 4, 5	FP-PK2571	DT 2, 3		
FP-3949844	DT 4, 5	FP-PK2572	DT 2, 3		
FP-3955393	DT 4, 5, 6, 7	FP-PK2573	DT 2, 3		
FP-3955394	DT 4, 5, 6, 7	FP-PK2574	DT 2, 3		
FP-3957440	DT 4, 5, 6	FP-PK2575	DT 2, 3		
FP-3957544	DT 1, 2, 3, 4, 5, 6	FP-PK6631	DT 2, 3		
FP-3958165	DT 4, 5, 6, 7	FP-PK6632	DT 2, 3		
FP-3958644*	DT 4, 5, 6	FP-PK6633	DT 2, 3		
FP-3958645*	DT 4, 5, 6	FP-PK6634	DT 2, 3		
FP-3958675	DT 4, 5	FP-PK6635	DT 2, 3		
FP-3959052	DT 1, 2, 3, 4, 5, 6	FP-PK8815	DT 1		
FP-3963983	DT 4, 5, 6	FP-PK8816	DT 1		
FP-3963988	DT 4, 5, 6	FP-PK9041	DT 2		
FP-3965497	DT 5, 6	FP-PK9044	DT 2		
FP-3966675	DT 5, 6	FP-PK9045	DT 2		
FP-3966676	DT 5, 6	FP-PK9183	DT 5, 6		
FP-3967060	DT 4, 6	FP-PK9184	DT 5, 6		
FP-3967061	DT 4, 6	FP-PK9185	DT 4, 5		
FP-3967062	DT 4, 6	FP-PK9186	DT 4, 5		
FP-3967063	DT 4, 6	FP-PK9259	DT 5, 6		
FP-3967064	DT 4, 6	FP-PK9260	DT 4, 5		
FP-3968183	DT 6	FP-PK9669	DT 6		
FP-3969562*	DT 6, 7	FP-PK9670	DT 6		
FP-3969988	DT 1, 2, 3, 4, 5, 6	FP-PK9671	DT 6		
FP-3970126	DT 6	FP6B5.9PREM-OHL	DT 2, 3		
FP-3970127	DT 6				
FP-3970192	DT 6				
FP-3970880	DT 1, 2				
FP-3977063	DT 4, 5, 6				
FP-3990105	DT 4, 5, 6				
FP-4089173	DT 4, 5, 6				
FP-4089181	DT 4, 5, 6				
FP-4089182	DT 4, 5, 6				
FP-4089183	DT 5, 6				
FP-4089184	DT 5, 6				
FP-4089185	DT 4, 5				
FP-4089186	DT 4, 5				
FP-4089258	DT 4, 5, 6				
FP-4089259	DT 5, 6				
FP-4089260	DT 4, 5				
FP-4089342	DT 4, 5, 6, 7				
FP-4089602	DT 4, 5, 6				
FP-4089669	DT 6				
FP-4089670	DT 6				
FP-4089671	DT 6				
FP-4089672	DT 6				
FP-4089819	DT 4, 5, 6				
FP-4090035	DT 4, 5				
FP-4090037	DT 4, 5, 6				
FP-43828A	DT 1, 2, 3				
FP-4891178	DT 4, 5, 6, 7				
FP-4892795	DT 4, 5, 6, 7				
FP-4892796	DT 4, 5, 6, 7				
FP-4892797	DT 4, 5, 6, 7				
FP-4892798	DT 4, 5, 6, 7				
FP-4893693	DT 4, 5, 6, 7				
FP-4931041	DT 7				
FP-4932375*	DT 6, 7				
FP-4932376*	DT 6, 7				
FP-4932377*	DT 6, 7				
FP-4932378*	DT 6, 7				
FP-4936080	DT 4, 5, 6, 7				
FP-4937308	DT 7				
FP-4939587	DT 1, 2, 3, 4, 5, 6				
FP-4944710	DT 2, 3				
FP-4955354	DT 7				
FP-4955355	DT 7				
FP-4955365	DT 7				
FP-4955366	DT 7				
FP-6B59PREM	DT 1				
FP-6B59PREML	DT 2, 3				
FP-6B59PREMOH	DT 1				
FP-IFKISB624V	DT 4				
FP-PK0781	DT 4, 5				
FP-PK0782	DT 4, 5				
FP-PK0783	DT 4, 5				
FP-PK0784	DT 4, 5				
FP-PK0785	DT 4, 5				
FP-PK0838	DT 4, 5, 6				
FP-PK0839	DT 4, 5, 6				
FP-PK0840	DT 4, 5, 6				
FP-PK0841	DT 4, 5, 6				
FP-PK0842	DT 4, 5, 6				



Conversion Tables

Global Technology Behind Every Part

Decimal Equivalents

8THS.	16THS.	32NDS.	64THS.	DECIMALS	mm
			1/64	.015625	.396875
		1/32	3/64	.031250	.793750
	1/16		5/64	.046875	1.190625
			7/64	.062500	1.587500
		3/32	9/64	.078125	1.984375
			11/64	.093750	2.381250
1/8			13/64	.109375	2.778125
		5/32	15/64	.125000	3.175000
			17/64	.140625	3.571875
	3/16		19/64	.156250	3.968750
			21/64	.171875	4.365625
		7/32	23/64	.187500	4.762500
			25/64	.203125	5.159375
1/4			27/64	.218750	5.556250
		9/32	29/64	.234375	5.953125
			31/64	.250000	6.350000
	5/16		33/64	.265625	6.746875
			35/64	.281250	7.143750
		11/32	37/64	.296875	7.540625
			39/64	.312500	7.937500
3/8			41/64	.328125	8.334375
		13/32	43/64	.343750	8.731250
			45/64	.359375	9.128125
			47/64	.375000	9.525000
	7/16		49/64	.390625	9.921875
		15/32	51/64	.406250	10.318750
			53/64	.421875	10.715625
			55/64	.437500	11.112500
1/2			57/64	.453125	11.509375
		17/32	59/64	.468750	11.906250
			61/64	.484375	12.303125
	9/16		63/64	.500000	12.700000
				.515625	13.096875
		19/32		.531250	13.493750
				.546875	13.890625
		9/16		.562500	14.287500
				.578125	14.684375
		19/32		.593750	15.081250
				.609375	15.478125
5/8				.625000	15.875000
		21/32		.640625	16.271875
				.656250	16.668750
		11/16		.671875	17.065625
				.687500	17.462500
		23/32		.703125	17.859375
				.718750	18.256250
3/4				.734375	18.653125
				.750000	19.050000
		25/32		.765625	19.446875
				.781250	19.843750
	13/16			.796875	20.240625
				.812500	20.637500
		27/32		.828125	21.034375
				.843750	21.431250
		55/64		.859375	21.828125
7/8				.875000	22.225000
				.890625	22.621875
		29/32		.906250	23.018750
				.921875	23.415625
	15/16			.937500	23.812500
				.953125	24.209375
		31/32		.968750	24.606250
				.984375	25.003125
1				1.000000	25.003125

Inches to Millimeters

.001	0.0254mm
.002	0.0508mm
.003	0.0762mm
.004	0.1016mm
.005	0.1270mm
.006	0.1524mm
.007	0.1778mm
.008	0.2032mm
.009	0.2286mm
.010	0.2540mm
.020	0.5080mm
.030	0.7620mm
.040	1.0160mm
.050	1.2700mm
.060	1.5240mm
.070	1.7780mm
.080	2.0320mm
.090	2.2860mm
.100	2.5400mm

Millimeters to Inches

0.025mm	.000984
0.050mm	.001968
0.075mm	.002952
0.100mm	.003937
0.125mm	.004921
0.150mm	.005905
0.175mm	.006889
0.200mm	.007874
0.225mm	.008858
0.250mm	.009842
0.500mm	.019685
0.750mm	.029527
1.000mm	.039370
1.250mm	.049212
1.500mm	.059055
1.750mm	.068897
2.000mm	.078740
2.250mm	.088582
2.500mm	.098425

Conversion Formulae

28.349 gm./oz. 453.592 gm./lb.
16.387 cc/in. ³ 61.024 in. ³ /L
3.785 L/U.S. gal. 4.546 L/Imp. gal. 0.264 U.S. gal./L 0.220 Imp. gal./L

Control Part Number List



Year	Transmission	Valve Train	HP	CPL	VIN	Notes	Engine S/N
1988	Man & Auto	12V	160	804	8	No Intercooler	44325085 - 44547226
1988	Man & Auto	12V	160	804	8	No Intercooler	44325085 - 44547226
1988	Man & Auto	12V	160	804	8	No Intercooler	44325085 - 44547226
1989	Man & Auto	12V	160	804	8	No Intercooler	44325085 - 44547226
1989	Man & Auto	12V	160	804	8	No Intercooler	44325085 - 44547226
1989	Man & Auto	12V	160	804	8	No Intercooler	44325085 - 44547226
1990	Man & Auto	12V	160	804	8	No Intercooler	44325085 - 44547226
1990	Man & Auto	12V	160	804	8	No Intercooler	44325085 - 44547226
1990	Man & Auto	12V	160	804	8	No Intercooler	44325085 - 44547226
1991	Man & Auto	12V	160	804	8	No Intercooler	44325085 - 44547226
1991	Man & Auto	12V	160	804	8	No Intercooler	44325085 - 44547226
1991	Man & Auto	12V	160	804	8	No Intercooler	44325085 - 44547226
1991.5	Man & Auto	12V	160	1351	C	Intercooled	44577090 - 44689145
1991.5	Man & Auto	12V	160	1351	C	Intercooled	44577090 - 44689145
1991.5	Man & Auto	12V	160	1351	C	Intercooled	44577090 - 44689145
1992	Man & Auto	12V	160	1351	C	Intercooled	44577090 - 44689145
1992	Man & Auto	12V	160	1351	C	Intercooled	44577090 - 44689145
1992	Man & Auto	12V	160	1351	C	Intercooled	44577090 - 44689145
1992.5	Man & Auto	12V	160	1579	C	Intercooled	44815853 - up
1992.5	Man & Auto	12V	160	1579	C	Intercooled	44815853 - up
1992.5	Man & Auto	12V	160	1579	C	Intercooled	44815853 - up
1993	Man & Auto	12V	160	1579	C	Intercooled	44815853 - up
1993	Man & Auto	12V	160	1579	C	Intercooled	44815853 - up
1993	Man & Auto	12V	160	1579	C	Intercooled	44815853 - up
1994	Manual	12V	175	1816	C	pre 1/1/94 w/o Catalytic Convertor	
1994	Manual	12V	175	1816	C	pre 1/1/94 w/o Catalytic Convertor	
1994	Manual	12V	175	1816	C	pre 1/1/94 w/o Catalytic Convertor	
1994	Manual	12V	175	1816	C	pre 1/1/94 w/o Catalytic Convertor	
1994	Manual	12V	175	1550	C	after 1/1/94 w/Catalytic Convertor	
1994	Manual	12V	175	1550	C	after 1/1/94 w/Catalytic Convertor	
1994	Manual	12V	175	1550	C	after 1/1/94 w/Catalytic Convertor	
1994	Manual	12V	175	1550	C	after 1/1/94 w/Catalytic Convertor	
1994	Manual	12V	175	1550	C	after 1/1/94 w/Catalytic Convertor	
1994	Automatic	12V	160	1815	C	pre 1/1/94 w/o Catalytic Convertor	
1994	Automatic	12V	160	1815	C	pre 1/1/94 w/o Catalytic Convertor	
1994	Automatic	12V	160	1815	C	pre 1/1/94 w/o Catalytic Convertor	
1994	Automatic	12V	160	1815	C	pre 1/1/94 w/o Catalytic Convertor	
1994	Automatic	12V	160	1815	C	pre 1/1/94 w/o Catalytic Convertor	
1994	Automatic	12V	160	1549	C	after 1/1/94 w/Catalytic Convertor	
1994	Automatic	12V	160	1549	C	after 1/1/94 w/Catalytic Convertor	
1994	Automatic	12V	160	1549	C	after 1/1/94 w/Catalytic Convertor	
1994	Automatic	12V	160	1549	C	after 1/1/94 w/Catalytic Convertor	
1994	Automatic	12V	160	1549	C	after 1/1/94 w/Catalytic Convertor	
1995	Manual	12V	175	1550	C	w/Catalytic Convertor	
1995	Manual	12V	175	1550	C	w/Catalytic Convertor	
1995	Manual	12V	175	1550	C	w/Catalytic Convertor	
1995	Manual	12V	175	1550	C	w/Catalytic Convertor	
1995	Automatic	12V	160	1549	C	pre 1/1/95	
1995	Automatic	12V	160	1549	C	pre 1/1/95	
1995	Automatic	12V	160	1549	C	pre 1/1/95	
1995	Automatic	12V	160	1549	C	pre 1/1/95	
1995	Automatic	12V	160	1549	C	pre 1/1/95	
1995	Automatic	12V	160	1959	C	pre 1/1/95	
1995	Automatic	12V	160	1959	C	pre 1/1/95	
1995	Automatic	12V	160	1959	C	pre 1/1/95	

Control Part Number List



Year	Transmission	Valve Train	HP	CPL	VIN	Notes	Engine S/N
1995	Automatic	12V	160	1959	C	pre 1/1/95	
1995	Automatic	12V	160	1959	C	pre 1/1/95	
1995	Automatic	12V	160	1968	C	after 1/1/95	
1995	Automatic	12V	160	1968	C	after 1/1/95	
1995	Automatic	12V	160	1968	C	after 1/1/95	
1995	Automatic	12V	160	1968	C	after 1/1/95	
1995	Automatic	12V	160	1968	C	after 1/1/95	
1996	Manual	12V	215	2023	C	pre 1/1/96 - Exc Calif ETC	
1996	Manual	12V	215	2023	C	pre 1/1/96 - Exc Calif ETC	
1996	Manual	12V	215	2023	C	pre 1/1/96 - Exc Calif ETC	
1996	Manual	12V	215	2023	C	pre 1/1/96 - Exc Calif ETC	
1996	Manual	12V	215	2023	C	pre 1/1/96 - Exc Calif ETC	
1996	Manual	12V	215	2175	C	after 1/1/96 - Exc Calif	
1996	Manual	12V	215	2175	C	after 1/1/96 - Exc Calif	
1996	Manual	12V	215	2175	C	after 1/1/96 - Exc Calif	
1996	Manual	12V	215	2175	C	after 1/1/96 - Exc Calif	
1996	Manual	12V	215	2175	C	after 1/1/96 - Exc Calif	
1996	Automatic	12V	180	2022	C	pre 1/1/96 - Exc Calif ETC	
1996	Automatic	12V	180	2022	C	pre 1/1/96 - Exc Calif ETC	
1996	Automatic	12V	180	2022	C	pre 1/1/96 - Exc Calif ETC	
1996	Automatic	12V	180	2022	C	pre 1/1/96 - Exc Calif ETC	
1996	Automatic	12V	180	2022	C	pre 1/1/96 - Exc Calif ETC	
1996.5	Automatic	12V	180	2174	C	after 1/1/96 - Exc Calif	
1996.5	Automatic	12V	180	2174	C	after 1/1/96 - Exc Calif	
1996.5	Automatic	12V	180	2174	C	after 1/1/96 - Exc Calif	
1996.5	Automatic	12V	180	2174	C	after 1/1/96 - Exc Calif	
1996.5	Automatic	12V	180	2174	C	after 1/1/96 - Exc Calif	
1996	Man & Auto	12V	180	1863	C	Calif only w/EGR & Catalytic Converter	
1996	Man & Auto	12V	180	1863	C	Calif only w/EGR & Catalytic Converter	
1996	Man & Auto	12V	180	1863	C	Calif only w/EGR & Catalytic Converter	
1996	Man & Auto	12V	180	1863	C	Calif only w/EGR & Catalytic Converter	
1996	Man & Auto	12V	180	1863	C	Calif only w/EGR & Catalytic Converter	
1996.5	Man & Auto	12V	180	2308	C	Calif only w/EGR & Catalytic Converter	
1996.5	Man & Auto	12V	180	2308	C	Calif only w/EGR & Catalytic Converter	
1996.5	Man & Auto	12V	180	2308	C	Calif only w/EGR & Catalytic Converter	
1996.5	Man & Auto	12V	180	2308	C	Calif only w/EGR & Catalytic Converter	
1996.5	Man & Auto	12V	180	2308	C	Calif only w/EGR & Catalytic Converter	
1997	Manual	12V	215	2175	D	Exc Calif	
1997	Manual	12V	215	2175	D	Exc Calif	
1997	Manual	12V	215	2175	D	Exc Calif	
1997	Manual	12V	215	2175	D	Exc Calif	
1997	Manual	12V	215	2175	D	Exc Calif	
1997	Automatic	12V	180	2174	D	Exc Calif	
1997	Automatic	12V	180	2174	D	Exc Calif	
1997	Automatic	12V	180	2174	D	Exc Calif	
1997	Automatic	12V	180	2174	D	Exc Calif	
1997	Automatic	12V	180	2174	D	Exc Calif	
1997	Man & Auto	12V	180	1863	D	Calif only w/EGR	
1997	Man & Auto	12V	180	1863	D	Calif only w/EGR	
1997	Man & Auto	12V	180	1863	D	Calif only w/EGR	
1997	Man & Auto	12V	180	1863	D	Calif only w/EGR	
1997	Man & Auto	12V	180	1863	D	Calif only w/EGR	
1997	Man & Auto	12V	180	2308	D	Calif only w/EGR	
1997	Man & Auto	12V	180	2308	D	Calif only w/EGR	
1997	Man & Auto	12V	180	2308	D	Calif only w/EGR	
1997	Man & Auto	12V	180	2308	D	Calif only w/EGR	
1997	Man & Auto	12V	180	2308	D	Calif only w/EGR	

Control Part Number List



Year	Transmission	Valve Train	HP	CPL	VIN	Notes	Engine S/N
2001	Automatic	24V	235	2902	6	Exc Calif - HY35 - turbo ETC	
2001	Automatic	24V	235	2902	6	Exc Calif - HY35 - turbo ETC	
2001	6 sp Manual	24V	215	2415	6	Exc Calif ETH	
2001	6 sp Manual	24V	215	2415	6	Exc Calif ETH	
2001	6 sp Manual	24V	215	2415	6	Exc Calif ETH	
2001	6 sp Manual	24V	215	2415	6	Exc Calif ETH	
2001	6 sp Manual	24V	215	2415	6	Exc Calif ETH	
2001	6 sp Manual	24V	215	2415	6	Exc Calif ETH	
2001	6 sp Manual	24V	215	2415	6	Exc Calif ETH	
2001	6 sp Manual	24V	215	2415	6	Exc Calif ETH	
2001	6 sp Manual	24V	215	2415	6	Exc Calif ETH	
2001	6 sp Manual	24V	215	2415	6	Exc Calif ETH	
2001	6 sp Manual	24V	215	2906	6	Exc Calif ETH	
2001	6 sp Manual	24V	215	2906	6	Exc Calif ETH	
2001	6 sp Manual	24V	215	2906	6	Exc Calif ETH	
2001	6 sp Manual	24V	215	2906	6	Exc Calif ETH	
2001	6 sp Manual	24V	215	2906	6	Exc Calif ETH	
2001	6 sp Manual	24V	215	2906	6	Exc Calif ETH	
2001	6 sp Manual	24V	215	2415	6	Exc Calif ETH	
2001	6 sp Manual	24V	215	2415	6	Exc Calif ETH	
2001	6 sp Manual	24V	215	2415	6	Exc Calif ETH	
2001	6 sp Manual	24V	215	2415	6	Exc Calif ETH	
2001	6 sp Manual	24V	215	2415	6	Exc Calif ETH	
2001	Automatic	24V	215	2866	6	Calif only	
2001	Automatic	24V	215	2866	6	Calif only	
2001	Automatic	24V	215	2866	6	Calif only	
2001	Automatic	24V	215	2866	6	Calif only	
2001	Automatic	24V	215	2866	6	Calif only	
2001	Automatic	24V	215	2866	6	Calif only	
2001	Automatic	24V	215	2866	6	Calif only	
2001	Automatic	24V	215	2866	6	Calif only	
2001	Automatic	24V	215	2866	6	Calif only	
2001	Automatic	24V	215	2866	6	Calif only	
2001	Automatic	24V	215	2866	6	Calif only	
2001	Automatic	24V	215	2903	6	Calif only	
2001	Automatic	24V	215	2903	6	Calif only	
2001	Automatic	24V	215	2903	6	Calif only	
2001	Automatic	24V	215	2903	6	Calif only	
2001	Automatic	24V	215	2903	6	Calif only	
2001	Automatic	24V	215	2903	6	Calif only	
2001	Automatic	24V	215	2903	6	Calif only	
2001	Automatic	24V	215	2903	6	Calif only	
2001	Automatic	24V	215	2903	6	Calif only	
2001	5 sp Manual	24V	215	2497	6	Calif only	
2001	5 sp Manual	24V	215	2497	6	Calif only	
2001	5 sp Manual	24V	215	2497	6	Calif only	
2001	5 sp Manual	24V	215	2497	6	Calif only	
2001	5 sp Manual	24V	215	2497	6	Calif only	
2001	5 sp Manual	24V	215	2497	6	Calif only	
2001	5 sp Manual	24V	215	2497	6	Calif only	
2001	5 sp Manual	24V	215	2497	6	Calif only	
2001	5 sp Manual	24V	215	2497	6	Calif only	
2001	5 sp Manual	24V	215	2497	6	Calif only	
2001	5 sp Manual	24V	215	2905	6	Calif only	
2001	5 sp Manual	24V	215	2905	6	Calif only	
2001	5 sp Manual	24V	215	2905	6	Calif only	
2001	5 sp Manual	24V	215	2905	6	Calif only	
2001	5 sp Manual	24V	215	2905	6	Calif only	

	Engine	Notes	Piston Comments	Piston Kit	Piston Body	Piston Pin	Retainers	Ring Set
	6BTA5.9	W/Pin	.50MM	FP-PK0784	FP-3946156	FP-3934047	FP-3920691	FP-3806201
	6BTA5.9	W/Pin	1.00MM	FP-PK0785	FP-3946157	FP-3934047	FP-3920691	FP-3806203
	6BTA5.9	W/O pin	STD A Grade	FP-3800838	3946050	FP-3934047	FP-3920691	FP-3804990
	6BTA5.9	W/O pin	STD B Grade	FP-3800839	3946051	FP-3934047	FP-3920691	FP-3804990
	6BTA5.9	W/O pin	STD C Grade	FP-3800840	3946052	FP-3934047	FP-3920691	FP-3804990
	6BTA5.9	W/O pin	.50MM	FP-3800841	3946053	FP-3934047	FP-3920691	FP-3806201
	6BTA5.9	W/O pin	1.00MM	FP-3800842	3946054	FP-3934047	FP-3920691	FP-3806203
	6BTA5.9	W/Pin	STD A Grade	FP-PK0838	3946050	FP-3934047	FP-3920691	FP-3804990
	6BTA5.9	W/Pin	STD B Grade	FP-PK0839	3946051	FP-3934047	FP-3920691	FP-3804990
	6BTA5.9	W/Pin	STD C Grade	FP-PK0840	3946052	FP-3934047	FP-3920691	FP-3804990
	6BTA5.9	W/Pin	.50MM	FP-PK0841	3946053	FP-3934047	FP-3920691	FP-3806201
	6BTA5.9	W/Pin	1.00MM	FP-PK0842	3946054	FP-3934047	FP-3920691	FP-3806203
	6BTA5.9	W/O pin	STD A Grade	FP-3800838	3946050	FP-3934047	FP-3920691	FP-3804990
	6BTA5.9	W/O pin	STD B Grade	FP-3800839	3946051	FP-3934047	FP-3920691	FP-3804990
	6BTA5.9	W/O pin	STD C Grade	FP-3800840	3946052	FP-3934047	FP-3920691	FP-3804990
	6BTA5.9	W/O pin	.50MM	FP-3800841	3946053	FP-3934047	FP-3920691	FP-3806201
	6BTA5.9	W/O pin	1.00MM	FP-3800842	3946054	FP-3934047	FP-3920691	FP-3806203
	6BTA5.9	W/Pin	STD A Grade	FP-PK0838	3946050	FP-3934047	FP-3920691	FP-3804990
	6BTA5.9	W/Pin	STD B Grade	FP-PK0839	3946051	FP-3934047	FP-3920691	FP-3804990
	6BTA5.9	W/Pin	STD C Grade	FP-PK0840	3946052	FP-3934047	FP-3920691	FP-3804990
	6BTA5.9	W/Pin	.50MM	FP-PK0841	3946053	FP-3934047	FP-3920691	FP-3806201
	6BTA5.9	W/Pin	1.00MM	FP-PK0842	3946054	FP-3934047	FP-3920691	FP-3806203
	6BTA5.9	W/O pin	STD A Grade	FP-3800781	FP-3946153	FP-3934047	FP-3920691	FP-3804990
	6BTA5.9	W/O pin	STD B Grade	FP-3800782	FP-3946154	FP-3934047	FP-3920691	FP-3804990
	6BTA5.9	W/O pin	STD C Grade	FP-3800783	FP-3946155	FP-3934047	FP-3920691	FP-3804990
	6BTA5.9	W/O pin	.50MM	FP-3800784	FP-3946156	FP-3934047	FP-3920691	FP-3806201
	6BTA5.9	W/O pin	1.00MM	FP-3800785	FP-3946157	FP-3934047	FP-3920691	FP-3806203
	6BTA5.9	W/Pin	STD A Grade	FP-PK0781	FP-3946153	FP-3934047	FP-3920691	FP-3804990
	6BTA5.9	W/Pin	STD B Grade	FP-PK0782	FP-3946154	FP-3934047	FP-3920691	FP-3804990
	6BTA5.9	W/Pin	STD C Grade	FP-PK0783	FP-3946155	FP-3934047	FP-3920691	FP-3804990
	6BTA5.9	W/Pin	.50MM	FP-PK0784	FP-3946156	FP-3934047	FP-3920691	FP-3806201
	6BTA5.9	W/Pin	1.00MM	FP-PK0785	FP-3946157	FP-3934047	FP-3920691	FP-3806203
	6BTA5.9	W/O pin	STD A Grade	FP-3800781	FP-3946153	FP-3934047	FP-3920691	FP-3804990
	6BTA5.9	W/O pin	STD B Grade	FP-3800782	FP-3946154	FP-3934047	FP-3920691	FP-3804990
	6BTA5.9	W/O pin	STD C Grade	FP-3800783	FP-3946155	FP-3934047	FP-3920691	FP-3804990
	6BTA5.9	W/O pin	.50MM	FP-3800784	FP-3946156	FP-3934047	FP-3920691	FP-3806201
	6BTA5.9	W/O pin	1.00MM	FP-3800785	FP-3946157	FP-3934047	FP-3920691	FP-3806203
	6BTA5.9	W/Pin	STD A Grade	FP-PK0781	FP-3946153	FP-3934047	FP-3920691	FP-3804990
	6BTA5.9	W/Pin	STD B Grade	FP-PK0782	FP-3946154	FP-3934047	FP-3920691	FP-3804990
	6BTA5.9	W/Pin	STD C Grade	FP-PK0783	FP-3946155	FP-3934047	FP-3920691	FP-3804990
	6BTA5.9	W/Pin	.50MM	FP-PK0784	FP-3946156	FP-3934047	FP-3920691	FP-3806201
	6BTA5.9	W/Pin	1.00MM	FP-PK0785	FP-3946157	FP-3934047	FP-3920691	FP-3806203
	6BTA5.9	W/O pin	STD A Grade	FP-3800781	FP-3946153	FP-3934047	FP-3920691	FP-3804990
	6BTA5.9	W/O pin	STD B Grade	FP-3800782	FP-3946154	FP-3934047	FP-3920691	FP-3804990
	6BTA5.9	W/O pin	STD C Grade	FP-3800783	FP-3946155	FP-3934047	FP-3920691	FP-3804990
	6BTA5.9	W/O pin	.50MM	FP-3800784	FP-3946156	FP-3934047	FP-3920691	FP-3806201
	6BTA5.9	W/O pin	1.00MM	FP-3800785	FP-3946157	FP-3934047	FP-3920691	FP-3806203

	Engine	Notes	Piston Comments	Piston Kit	Piston Body	Piston Pin	Retainers	Ring Set
	6BTA5.9	W/O pin	STD C Grade	FP-3800783	FP-3946155	FP-3934047	FP-3920691	FP-3804990
	6BTA5.9	W/O pin	.50MM	FP-3800784	FP-3946156	FP-3934047	FP-3920691	FP-3806201
	6BTA5.9	W/O pin	1.00MM	FP-3800785	FP-3946157	FP-3934047	FP-3920691	FP-3806203
	6BTA5.9	W/Pin	STD A Grade	FP-PK0781	FP-3946153	FP-3934047	FP-3920691	FP-3804990
	6BTA5.9	W/Pin	STD B Grade	FP-PK0782	FP-3946154	FP-3934047	FP-3920691	FP-3804990
	6BTA5.9	W/Pin	STD C Grade	FP-PK0783	FP-3946155	FP-3934047	FP-3920691	FP-3804990
	6BTA5.9	W/Pin	.50MM	FP-PK0784	FP-3946156	FP-3934047	FP-3920691	FP-3806201
	6BTA5.9	W/Pin	1.00MM	FP-PK0785	FP-3946157	FP-3934047	FP-3920691	FP-3806203
	6BTA5.9	W/O pin	STD A Grade	FP-3800838	3946050	FP-3934047	FP-3920691	FP-3804990
	6BTA5.9	W/O pin	STD B Grade	FP-3800839	3946051	FP-3934047	FP-3920691	FP-3804990
	6BTA5.9	W/O pin	STD C Grade	FP-3800840	3946052	FP-3934047	FP-3920691	FP-3804990
	6BTA5.9	W/O pin	.50MM	FP-3800841	3946053	FP-3934047	FP-3920691	FP-3806201
	6BTA5.9	W/O pin	1.00MM	FP-3800842	3946054	FP-3934047	FP-3920691	FP-3806203
	6BTA5.9	W/Pin	STD A Grade	FP-PK0838	3946050	FP-3934047	FP-3920691	FP-3804990
	6BTA5.9	W/Pin	STD B Grade	FP-PK0839	3946051	FP-3934047	FP-3920691	FP-3804990
	6BTA5.9	W/Pin	STD C Grade	FP-PK0840	3946052	FP-3934047	FP-3920691	FP-3804990
	6BTA5.9	W/Pin	.50MM	FP-PK0841	3946053	FP-3934047	FP-3920691	FP-3806201
	6BTA5.9	W/Pin	1.00MM	FP-PK0842	3946054	FP-3934047	FP-3920691	FP-3806203
	6BTA5.9	W/O pin	STD A Grade	FP-3800838	3946050	FP-3934047	FP-3920691	FP-3804990
	6BTA5.9	W/O pin	STD B Grade	FP-3800839	3946051	FP-3934047	FP-3920691	FP-3804990
	6BTA5.9	W/O pin	STD C Grade	FP-3800840	3946052	FP-3934047	FP-3920691	FP-3804990
	6BTA5.9	W/O pin	.50MM	FP-3800841	3946053	FP-3934047	FP-3920691	FP-3806201
	6BTA5.9	W/O pin	1.00MM	FP-3800842	3946054	FP-3934047	FP-3920691	FP-3806203
	6BTA5.9	W/Pin	STD A Grade	FP-PK0838	3946050	FP-3934047	FP-3920691	FP-3804990
	6BTA5.9	W/Pin	STD B Grade	FP-PK0839	3946051	FP-3934047	FP-3920691	FP-3804990
	6BTA5.9	W/Pin	STD C Grade	FP-PK0840	3946052	FP-3934047	FP-3920691	FP-3804990
	6BTA5.9	W/Pin	.50MM	FP-PK0841	3946053	FP-3934047	FP-3920691	FP-3806201
	6BTA5.9	W/Pin	1.00MM	FP-PK0842	3946054	FP-3934047	FP-3920691	FP-3806203
	6BTA5.9	W/O pin	STD	FP-4089260	FP-3958675	FP-3934047	FP-3920691	FP-4089258
	6BTA5.9	W/O pin	.50MM	FP-4089185	FP-3949843	FP-3934047	FP-3920691	FP-4089181
	6BTA5.9	W/O pin	1.00MM	FP-4089186	FP-3949844	FP-3934047	FP-3920691	FP-4089182
	6BTA5.9	W/Pin	STD	FP-PK9260	FP-3958675	FP-3934047	FP-3920691	FP-4089258
	6BTA5.9	W/Pin	.50MM	FP-PK9185	FP-3949843	FP-3934047	FP-3920691	FP-4089181
	6BTA5.9	W/Pin	1.00MM	FP-PK9186	FP-3949844	FP-3934047	FP-3920691	FP-4089182
	6BTA5.9	W/O pin	STD	FP-4089260	FP-3958675	FP-3934047	FP-3920691	FP-4089258
	6BTA5.9	W/O pin	.50MM	FP-4089185	FP-3949843	FP-3934047	FP-3920691	FP-4089181
	6BTA5.9	W/O pin	1.00MM	FP-4089186	FP-3949844	FP-3934047	FP-3920691	FP-4089182
	6BTA5.9	W/Pin	STD	FP-PK9260	FP-3958675	FP-3934047	FP-3920691	FP-4089258
	6BTA5.9	W/Pin	.50MM	FP-PK9185	FP-3949843	FP-3934047	FP-3920691	FP-4089181
	6BTA5.9	W/Pin	1.00MM	FP-PK9186	FP-3949844	FP-3934047	FP-3920691	FP-4089182
	6BTA5.9	W/O pin	STD	FP-4089260	FP-3958675	FP-3934047	FP-3920691	FP-4089258
	6BTA5.9	W/O pin	.50MM	FP-4089185	FP-3949843	FP-3934047	FP-3920691	FP-4089181
	6BTA5.9	W/O pin	1.00MM	FP-4089186	FP-3949844	FP-3934047	FP-3920691	FP-4089182
	6BTA5.9	W/Pin	STD	FP-PK9260	FP-3958675	FP-3934047	FP-3920691	FP-4089258
	6BTA5.9	W/Pin	.50MM	FP-PK9185	FP-3949843	FP-3934047	FP-3920691	FP-4089181
	6BTA5.9	W/Pin	1.00MM	FP-PK9186	FP-3949844	FP-3934047	FP-3920691	FP-4089182
	6BTA5.9	W/O pin	STD	FP-4089259	FP-3965497	FP-3934047	FP-3920691	FP-4089258
	6BTA5.9	W/O pin	.50MM	FP-4089183	FP-3966675	FP-3934047	FP-3920691	FP-4089181
	6BTA5.9	W/O pin	1.00MM	FP-4089184	FP-3966676	FP-3934047	FP-3920691	FP-4089182
	6BTA5.9	W/Pin	STD	FP-PK9259	FP-3965497	FP-3934047	FP-3920691	FP-4089258
	6BTA5.9	W/Pin	.50MM	FP-PK9183	FP-3966675	FP-3934047	FP-3920691	FP-4089181

Control Part Number List



Year	Transmission	Valve Train	HP	CPL	VIN	Notes	Engine S/N
2006	6 sp Manual	24V	325	8348	C	49 States w/Catalytic Converter - Exc Calif	
2006	48RE Automatic	24V	325	8345	C	Calif w/Catalytic Converter	
2006	48RE Automatic	24V	325	8345	C	Calif w/Catalytic Converter	
2006	48RE Automatic	24V	325	8345	C	Calif w/Catalytic Converter	
2006	48RE Automatic	24V	325	8345	C	Calif w/Catalytic Converter	
2006	48RE Automatic	24V	325	8345	C	Calif w/Catalytic Converter	
2006	48RE Automatic	24V	325	8345	C	Calif w/Catalytic Converter	
2006	6 sp Manual	24V	325	8349	C	Calif w/Catalytic Converter	
2006	6 sp Manual	24V	325	8349	C	Calif w/Catalytic Converter	
2006	6 sp Manual	24V	325	8349	C	Calif w/Catalytic Converter	
2006	6 sp Manual	24V	325	8349	C	Calif w/Catalytic Converter	
2006	6 sp Manual	24V	325	8349	C	Calif w/Catalytic Converter	
2006	6 sp Manual	24V	325	8349	C	Calif w/Catalytic Converter	
2007	All	24V	325	1000	C	All	
2007	All	24V	325	1000	C	All	
2007	All	24V	325	1000	C	All	
2007	All	24V	325	1000	C	All	
2007	All	24V	325	1000	C	All	
2007	All	24V	325	1000	C	All	
2007	All	24V	325	1083	C	All	
2007	All	24V	325	1083	C	All	
2007	All	24V	325	1083	C	All	
2007	All	24V	325	1083	C	All	
2007	All	24V	325	1083	C	All	
2007	All	24V	325	1083	C	All	
2007	All	24V	325	1083	C	All	
2007	All	24V	325	1091	C	All	
2007	All	24V	325	1091	C	All	
2007	All	24V	325	1091	C	All	
2007	All	24V	325	1091	C	All	
2007	All	24V	325	1091	C	All	
2007	All	24V	325	1091	C	All	
2007	All	24V	325	1091	C	All	
2007	All	24V	325	1095	C	All	
2007	All	24V	325	1095	C	All	
2007	All	24V	325	1095	C	All	
2007	All	24V	325	1095	C	All	
2007	All	24V	325	1095	C	All	
2007	All	24V	325	1095	C	All	
2007	All	24V	325	1095	C	All	
2007	All	24V	305	1257	A	All	
2007	All	24V	305	1264	A	All	
2007	All	24V	305	2885	A	All	
2007	All	24V	305	8231	A	All	
2007	All	24V	305	8232	A	All	
2008	All	24V	325	TBD	C	All	
2008	All	24V	325	TBD	C	All	
2008	All	24V	325	TBD	C	All	
2008	All	24V	325	TBD	C	All	
2008	All	24V	325	TBD	C	All	
2008	All	24V	305	8230	A	All	
2008	All	24V	305	8231	A	All	
2008	All	24V	305	8233	A	All	
2008	All	24V	305	8234	A	All	
2009	All	24V	305	TBD	A	All	



Valve Stem Seal Identification 5.9L & 6.7L ISB Engines

Global Technology Behind Every Part

Cummins has made changes to the valve stem seals for ISB engines.

All 24 valve ISB engines utilizing the VP44 injection pump use intake valve stem seal part number FP-3942989 and contain a *Yellow* Viton center.

The exhaust valve stem seal part number FP-3945438 contains a *Green* Viton center.

Both seals are used in engines built between 1998 - 2002.

Engine serial numbers 46239408 & below.

ISB Engine Utilizing VP44 Injection Pump

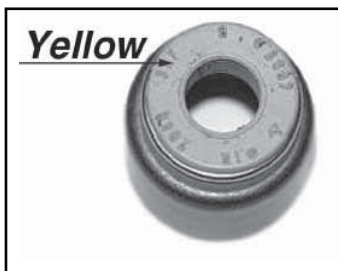

Intake Valve Stem Seal
Yellow Viton® Center
Part No. FP-3942989

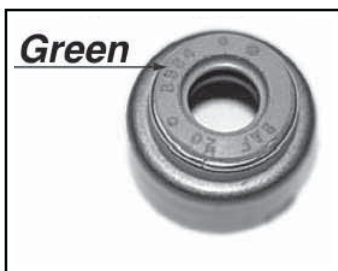

Exhaust Valve Stem Seal
Green Viton® Center
Part No. FP-3945438

Beginning in 2003 thru 2009, engines with HPCR utilized a "Top Hat" design.

The intake valve stem seal part number is FP-3955393 and contains a *Yellow* Viton center.

The exhaust valve stem seal part number FP-3955394 contains a *Green* Viton center.

Engine serial numbers 46239409 & above.

ISB Engines with HPCR 2003-2009 Top Hat Design

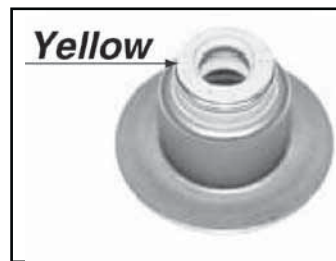

Intake Valve Stem Seal
Yellow Viton® Center
Part No. FP-3955393

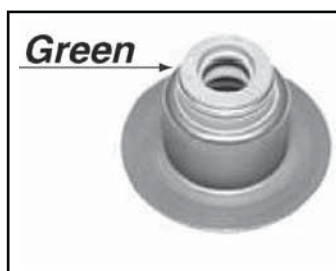

Exhaust Valve Stem Seal
Green Viton® Center
Part No. FP-3955394

See catalog inside back cover for the FP Diesel Tech Tip covering Cummins ISB Engine Valve Stem Seals

Viton is a registered trademark of DuPont Performance Elastomers L.L.C.

FIND ALL THE PARTS YOU NEED.

LOOK UP ANY PART ANYTIME

www.FMe-cat.com

FMe-cat is the online solution that offers fast, easy access to virtual catalog pages covering thousands of FP Diesel® replacement engine parts for commercial vehicles. The interactive catalog simplifies the process of locating engine components for medium- and heavy-duty applications and enables users to easily navigate in a virtual catalog environment.

NEW!



Click on a part number from the list below to view the details.

Part Type	Part Number	Qty	Oversizes	Comments
Complete Overhaul Kit	FP-6B59PREMOM	1		Multi-Purpose Engines; 6B5.9; Pre 1991; Premium; With Front & Rear Seals and Upper & Lower Gasket Sets
	FP6B5.9PREM-OHL	1		Multi-Purpose Engines; 6B5.9; Late; 1991 to Present; Premium; With Front & Rear Seals and Upper & Lower Gasket Sets
In-Frame Overhaul Kit	FP-6B59PREM	1		Multi-Purpose Engines; 6B5.9; Premium; With Upper Gasket Set & Pan Gasket
	FP-6B59PREML	1		Multi-Purpose Engines; 6B5.9; Late; Premium; With Upper Gasket Set & Pan Gasket
Piston Kit w/Ring Set	FP-PK12742B	1		Multi-Purpose Engines
Piston Kit w/Rings & Bearings	FP-PK22742B	1		Multi-Purpose Engines

APPLICATION LOOK-UP

- User-friendly interface always features the most complete product offering and latest coverage data
- Offers fast, easy access to virtual catalog pages covering the thousands of FP Diesel® replacement components

Visit FMe-cat.com and click on the **Commercial vehicle!**



FP DIESEL SMART TIP

Cummins® utilizes several types of valve stem seals on the 24 valve ISB engines, depending on the fuel system. Please review the references below to assist you in ordering the correct valve stem seals.

For 1998-2002 engines using the VP44 Injection Pump, with serial number 46239408 and below use:



INTAKE VALVE STEM SEAL
Yellow Viton® Center
Part No. FP-3942989



EXHAUST VALVE STEM SEAL
Green Viton® Center
Part No. FP-3945438

For 2003-2009 engines using the HPCR System, with serial number 46239409 and above use:



INTAKE VALVE STEM SEAL
Yellow Viton® Center
Part No. FP-3955393



EXHAUST VALVE STEM SEAL
Green Viton® Center
Part No. FP-3955394





FP Diesel Gaskets

- Innovative, problem-solving gaskets, including in-frame and overhaul sets
- Proven design elements that address the heavy-duty engine repair environment
- Engineered gasket materials and designs to ensure lasting, trouble-free sealing



Valvetrain Components

- Manufactured to the highest quality standards
- OEM specification materials used with upgrades to super alloys such as stellite, nickel, nimonic and inconel where needed for problem applications
- Available parts include valves, springs, guides, keepers, rotocaps, rocker parts, lifters, seals, seats and more



Commercial, Ag
and Industrial

www.FMe-cat.com

- Commercial vehicle electronic catalog – available at www.FMe-cat.com
- User friendly interface features the most complete product offering and latest coverage data
- Online solution offers fast, easy access to virtual catalog pages covering the thousands of FP Diesel® components
- Eases locating components for heavy-duty applications and enables users to accurately navigate in a virtual catalog environment of commercial vehicles

GLOBAL TECHNOLOGY behind every part